

Compact Microstrip Lowpass Filter with Ultra-Wide Stopband using Stepped-Impedance Trapezoid Resonators

G. Zhang, J. Wang, Y. Dou, and H. Cui

Ministerial Key Laboratory of JGMT,
Nanjing University of Science and Technology, Nanjing 210094, China
elegzhang@gmail.com, elejpwang@gmail.com, eledouy@gmail.com, elehfc@gmail.com

Abstract — A new microstrip lowpass filter with compact size and ultra-wide stopband is presented. The resonance properties of a microstrip main transmission line parallel loaded with the stepped-impedance trapezoid resonator are studied. Analysis results reveal that a compact size and ultra-wide stopband lowpass filter can be realized by properly introducing multiple stepped-impedance trapezoid resonators in the design. A demonstration filter with 3 dB cutoff frequency at 0.8 GHz has been designed, fabricated, and measured. Results indicate that the proposed filter is able to suppress the 17th harmonic response by 15 dB, together with a small size of $0.057 \lambda_g \times 0.077 \lambda_g$, where λ_g is the guided wavelength at 0.8 GHz.

Index Terms — Compact, lowpass filter, microstrip, trapezoid resonator, and ultra-wide.

I. INTRODUCTION

Planar lowpass filters with compact size and high performance are in great demand for modern wireless communication systems to suppress harmonics and spurious signals. Conventional lowpass filters using shunt stubs or high-low impedance transmission lines have been widely used in microwave systems for their excellent characteristics [1]. However, compact size and high performance are hard to achieve simultaneously. Therefore, many works report attempts to achieve both size reduction and performance enhancement [2–11].

In general, there are two methods to design a lowpass filter with compact size and wide stopband. The first method is to form a lowpass

filter by cascading multiple resonators [2-5]. With this method, Li et al. designed a lowpass filter by cascading multi-radial patch resonators [2]. Although, sharp roll-off was achieved, the size of the filter was relatively large and only the 6th harmonic response was suppressed. A microstrip lowpass filter with low insertion loss and sharp roll-off was proposed by cascading modified semi-circular and semi-elliptical microstrip patch resonators [3]. However, the circuit size and passband performance still need improvement. Therefore, to further improve the stopband performance, Ma et al. proposed a lowpass filter by cascading LC resonant structures and transformed radial stubs. Although, better than 13th harmonic suppression was realized, this method increased design complexity and circuit area [4]. As for the work reported in [5], a microstrip lowpass filter with compact size and ultra-wide stopband had been achieved but at the cost of a relatively complex circuit design. The second method is to design a lowpass filter by using modified stepped impedance hairpin resonators [6-8]. Using stepped impedance hairpin resonators with radial stubs, Wei et al., proposed a lowpass filter with 7th harmonic suppression performance [6]. Although, a compact design had been realized with this method, further improvement should be carried out in stopband bandwidth. The stopband performance should also be improved in [7], as the compact lowpass filter using a coupled-line hairpin unit, one spiral slot, and two open stubs only achieve 10 dB attenuation up to 20 GHz inside the stopband. A very wide stopband lowpass filter is achieved with a novel application of shunt open-stubs at the feed points of a center fed coupled-line hairpin resonator [8], but the

reflection loss is relatively large. In addition, using defected ground structure is also a popular and useful way [9-11]. A lowpass filter composed of semi-circular defected ground structures and semi-circular stepped-impedance shunt stubs is proposed in [9], which increases the circuit complexity and circuit size.

The motivation of this paper is to design a new microstrip lowpass filter with both compact size and ultra-wide stopband. To achieve compact size and ultra-wide stopband rejection, stepped-impedance trapezoid resonators are introduced and parallel loaded on the main transmission line of the filter. A demonstration filter with 3 dB cutoff frequency at 0.8 GHz has been designed, fabricated, and measured. Measured results indicate that the designed filter has an ultra-wide stopband with better than 15 dB suppression up to 13.7 GHz. Furthermore, the size of the filter is only $11.6 \times 15.7 \text{ mm}^2$, which corresponds to a compact electrical size of $0.057 \lambda_g \times 0.077 \lambda_g$, where λ_g is the guided wavelength at 0.8 GHz.

II. FILTER DESIGN

Figure 1 shows the layout of the proposed lowpass filter, which is composed of a high impedance microstrip main transmission line and five stepped-impedance trapezoid resonators. Each stepped-impedance trapezoid resonator is composed of a high impedance transmission line and a trapezoidal patch, which are connected in series. Figure 2 shows the lumped-element equivalent circuit of the presented lowpass filter. In the circuit, the high impedance line is mainly represented by the inductance L_0 and L_1 . The symbols C_a , C_b , and C_c mainly represent the capacitances between the resonator 1, 2, 3, and the ground plane, respectively, while L_a , L_b , and L_c mainly represent the inductances of the high impedance of the stepped-impedance resonator 1, 2, and 3. The symbol C_{bc} means the coupling capacitance between resonators 1 and 3. The capacitor and inductor values of the lumped-element equivalent circuit of the proposed lowpass filter are given as follows: $C_a = 4.6 \text{ pF}$, $C_b = 1.9 \text{ pF}$, $C_c = 6.6 \text{ pF}$, $C_{bc} = 0.1 \text{ pF}$, $L_0 = 5.6 \text{ nH}$, $L_1=15.8 \text{ nH}$, $L_a=0.9 \text{ nH}$, $L_b=0.92 \text{ nH}$, and $L_c=0.27 \text{ nH}$.

To illustrate the design theory of the proposed filter, frequency responses of four stepped-impedance rectangular trapezoid resonators and

one stepped-impedance isosceles trapezoid resonator have been studied, respectively. As can be seen from Fig. 3 (a), a microstrip main transmission line with only two stepped-impedance rectangular trapezoid resonators, i.e., resonator 1, exhibits a wide stopband together with one transmission pole (TP) at about 4.4 GHz. In order to suppress the undesired frequency response, another two stepped-impedance rectangular trapezoid resonators, i.e., resonator 2, are also introduced to the design.

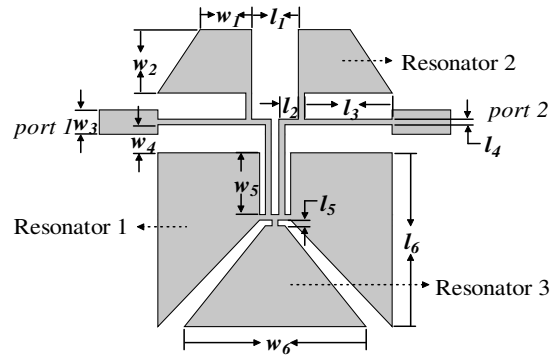

Fig. 1. Layout of proposed lowpass filter.

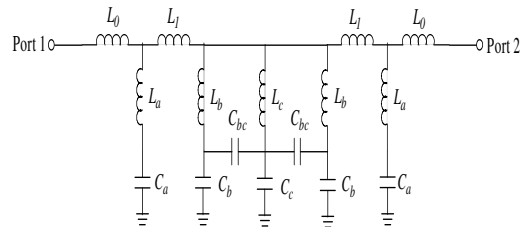

Fig. 2. Lumped-element equivalent circuit of the proposed lowpass filter.

Figure 3 (b) investigates the resonant properties of the stepped-impedance trapezoid resonators. It can be seen that one transmission zero (TZ) at about 4.4 GHz in the stopband is achieved. This transmission zero is caused by the resonance of loaded stepped-impedance trapezoid resonators and its frequency location can be controlled by the structure parameters of the stepped-impedance trapezoid resonators. Based on the investigation mentioned above, if we can properly combine the four stepped-impedance rectangular trapezoid resonators in a filter, the mutual suppression of spurious passbands and thereby a better stopband performance is

expected to be achieved. Figure 3 (c) shows the frequency response of the filter with four stepped-impedance rectangular trapezoid resonators, i.e., resonators 1 and 2. As expected, by locating the transmission zero in Fig. 3 (b) around the position of spurious response appeared at about 4.4 GHz in Fig. 3 (a), we finally achieve the new lowpass filter with an enhanced stopband performance.

In order to achieve sharp roll-off rate, one stepped-impedance isosceles trapezoid resonator, i.e., resonator 3, is also introduced to the filter. It can be seen in Fig. 3 (d) a sharp roll-off rate is achieved by the adoption of resonator 3. Therefore, if we properly combine the three types of stepped-impedance trapezoid resonators, i.e., resonators 1, 2, and 3, in one filter, a compact microstrip lowpass filter with ultra-wide stopband can be realized.

The new lowpass filter is designed and fabricated based on the analysis mentioned above. The structure parameters are as follows: $l_1 = 2.2$ mm, $l_2 = 0.9$ mm, $l_3 = 4.5$ mm, $l_4 = 0.2$ mm, $l_5 = 0.2$ mm, $l_6 = 9.3$ mm, $w_1 = 2.6$ mm, $w_2 = 3.4$ mm, $w_3 = 1.16$ mm, $w_4 = 1.4$ mm, $w_5 = 3.4$ mm, and $w_6 = 9.3$ mm. The substrate used here has a relative dielectric constant of 3.38 and a thickness of 0.508 mm. Figure 4 is the photograph of the proposed lowpass filter.

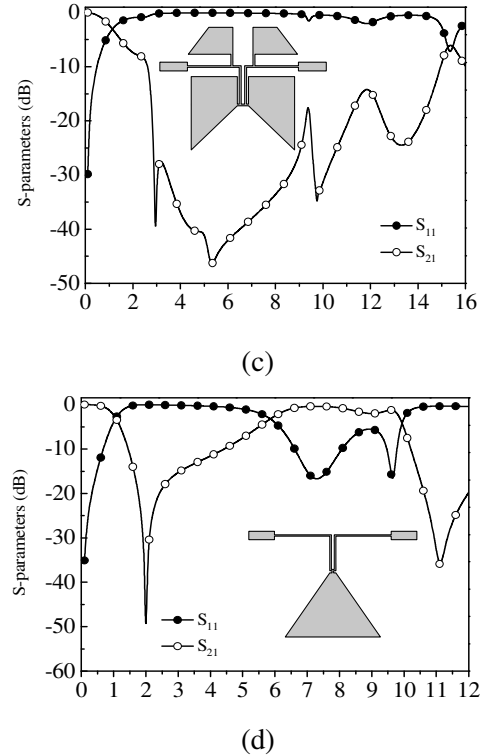
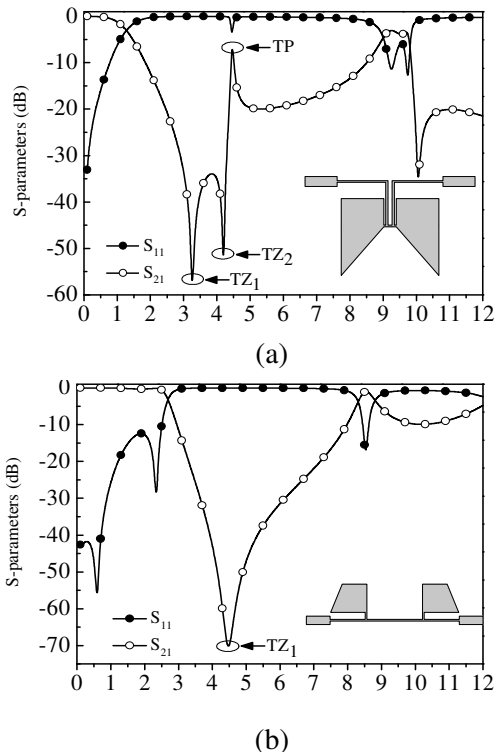

Fig. 3. Simulated S-parameters of the studied resonators; a) filter with stepped-impedance rectangular trapezoid resonator 1, b) filter with stepped-impedance rectangular trapezoid resonator 2, c) filter with stepped-impedance rectangular trapezoid resonator 1 and 2, and d) filter with stepped-impedance isosceles trapezoid resonator 3.

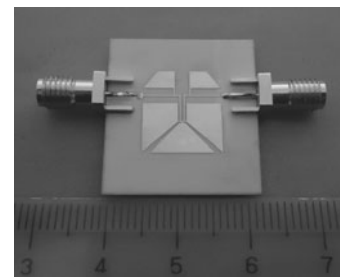

Fig. 4. Photograph of the proposed lowpass filter.

III. SIMULATION AND MEASUREMENT RESULTS

Simulation was accomplished by using EM simulation software ANSOFT HFSS 12. The comparisons among the circuit model EM simulated results and the equivalent lumped element circuit results are given in Fig. 5.

Measurement was carried out on an Agilent 8722ES network analyser. Figure 6 shows the simulated and measured results, which are in good agreement. As can be observed from Fig. 6, the measured 3 dB cutoff frequency f_c is located at 0.8 GHz, as expected. Figure 6 also shows that the spurious frequencies suppressed by better than 15 dB from 2.36 GHz up to 13.7 GHz. Thus, the proposed filter has a property of 17th harmonic suppression. Furthermore, the proposed filter exhibits a small electrical size of $0.057 \lambda_g \times 0.077 \lambda_g$, where λ_g is the guided wavelength at 0.8 GHz. For comparison, Table I summarizes the performance of some published lowpass filters. As can be seen from the table, our proposed filter has the properties of compact size, simple circuit topology, and ultra-wide stopband among the quoted filters.

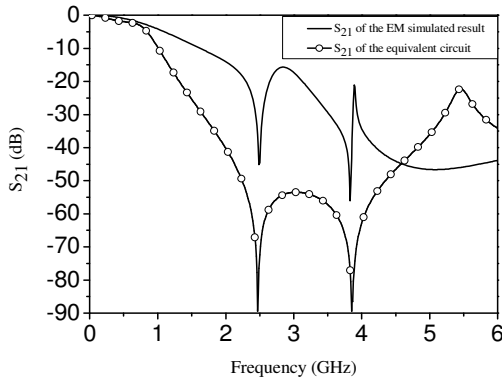

Fig. 5. Comparisons among the equivalent circuit model calculated results and EM simulated results.

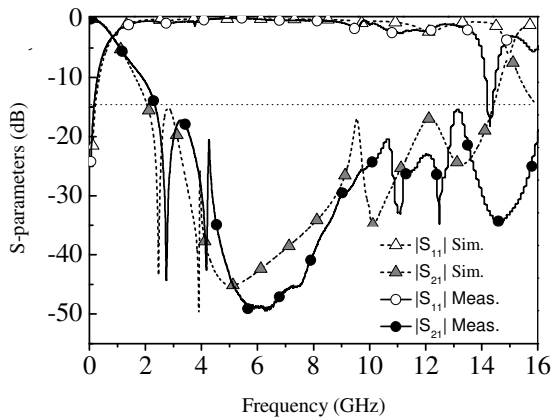

Fig. 6. Simulated and measured S-parameters of the proposed filter.

Table I: Performance comparisons among published filters and proposed ones.

Ref.	Harmonic suppression	Cutoff frequency (GHz)	Circuit size
2	6 th	2.4	$0.351\lambda_g \times 0.106\lambda_g$
3	6 th	3.12	$0.395\lambda_g \times 0.151\lambda_g$
4	13 th	3	$0.310\lambda_g \times 0.240\lambda_g$
5	16 th	1	$0.111\lambda_g \times 0.091\lambda_g$
6	7 th	1.67	$0.104\lambda_g \times 0.104\lambda_g$
7	10 th	2	$0.101\lambda_g \times 0.150\lambda_g$
8	9 th	0.5	$0.104\lambda_g \times 0.214\lambda_g$
9	5 th	2.7	$0.134\lambda_g \times 0.323\lambda_g$
This work	17 th	0.8	$0.057\lambda_g \times 0.077\lambda_g$

IV. CONCLUSION

A new microstrip lowpass filter is presented in this letter. One prototype filter with 3 dB cutoff frequency at 0.8 GHz has been demonstrated. Results indicate that the demonstrator has the properties of compact size, good passband performance, and ultra-wide stopband. With all these good features, the proposed filter is applicable for modern communication systems.

ACKNOWLEDGMENT

This work was supported by the Nature Science Foundation of China under Grant No.61101047 and the Specialized Research Fund for the Doctoral Program by the Ministry of Education of China under Grant No.20113219120015.

REFERENCES

- [1] D. Pozar, *Microwave Engineering*, Wiley, USA, pp. 412-415, 2005.
- [2] J.-L. Li, S.-W. Qu, and Q. Xue, "Compact microstrip lowpass filter with sharp roll-off and wide stop-band," *IEE Electron. Lett.*, vol. 45, no. 2, pp. 110-111, Jan. 2009.
- [3] M. Hayati, A. Sheikhi, and A. Lotfi, "Compact lowpass filter with wide stopband using modified

semi-elliptic and semi-circular microstrip patch resonator,” *IEE Electron. Lett.*, vol. 46, no. 22, pp. 1507-1509, Oct. 2010.

- [4] K. Ma and K. Yeo, “New ultra-wide stopband lowpass filter using transformed radial stubs,” *IEEE Trans. Microw. Theory Tech.*, vol. 59, no. 3, pp. 604-611, Mar. 2011.
- [5] J. Wang, H. Cui, and G. Zhang, “Design of compact microstrip lowpass filter with ultra-wide stopband,” *IEE Electron. Lett.*, vol. 48, no. 14, pp. 854-856, July 2012.
- [6] X. Wei, P. Wang, M. Liu, and Y. Shi, “Compact wide-stopband lowpass filter using stepped impedance hairpin resonator with radial stubs,” *IEE Electron. Lett.*, vol. 47, no. 15, pp. 862-863, July 2011.
- [7] F. Wei, L. Chen, and X.-W. Shi, “Compact lowpass filter based on coupled-line hairpin unit,” *IEE Electron. Lett.*, vol. 48, no. 7, pp. 379-381, Mar. 2012.
- [8] V. Velidi and S. Sanyal, “Sharp roll-off lowpass filter with wide stopband using stub-loaded coupled-line hairpin unit,” *IEEE Microw. Wirel. Compon. Lett.*, vol. 21, no. 6, pp. 301-303, June 2011.
- [9] F. Wei, X.-W. Shi, B. Li, Q. Huang, and X. Wang, “Design of a compact microstrip low-pass filter using defected ground structure,” *Microwave Opt. Technol. Lett.*, vol. 50, no. 12, pp. 3157-3160, Dec. 2008.
- [10] G. Al-Omar, S. Mahmoud, and A. Al-Zayed, “Lowpass and bandpass filter designs based on DGS with complementary split ring resonators,” *Applied Computational Electromagnetic Society (ACES) Journal*, vol. 26, no. 11, pp. 907-914, Nov. 2011.
- [11] M. Challal, A. Boutejdar, M. Dehmas1, A. Azrar, and A. Omar, “Compact microstrip low-pass filter design with ultra-wide reject band using a novel quarter-circle DGS shape,” *Applied Computational Electromagnetic Society (ACES) Journal*, vol. 27, no. 10, pp. 808-815, Oct. 2012.



Gang Zhang received the B.S. degree in Electronics and Information Engineering from NJUST, Nangjing, China, in 2010. He is currently working toward the Ph.D. degree in Electromagnetic Field and Microwave Technology in NJUST. His research interest is the design of miniaturized high performance microwave/millimeter-wave passive device and numerical methods in electromagnetics.



Jianpeng Wang received the M. Sc. and Ph. D. degree from UESTC, Chengdu, China, in 2004, and 2007, respectively, both in Electronic Engineering. Since January 2008, he has been with the Ministerial Key Laboratory of JGMT, School of Electronic and Optical Engineering, NJUST, where he is currently an Associate Professor. His research interests include the high performance microwave/millimeter-wave passive components, circuits and systems realized on PCB, LTCC, etc.

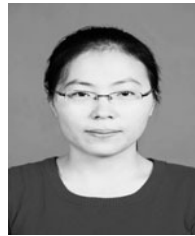

Yan Dou received the B.S. degree in Electronics and Information Engineering from Anhui University, Hefei, China, in 2011. She is currently working toward the Master's degree in Electromagnetic Field and Microwave Technology in NJUST. Her research interest is the design of miniaturized high performance microwave passive device.



Haifei Cui received the B.S. degree in Electronics and Information Engineering from Anhui University, Hefei, China, in 2008. He is currently working toward the Ph.D. degree in Electromagnetic Field and Microwave Technology in NJUST. His research interest is the design of miniaturized high performance microwave passive device.