

Switchable Multiband Monopole CRLH Antenna

Abdullah K. Alqallaf¹, Rabie K. Dib², and Muhammad F. Karim³

¹Electrical Engineering Department, College of Engineering and Petroleum
Kuwait University, P. O. Box 5969, Safat 13060 Kuwait
al.qallaf@ku.edu.kw

²Electronics Engineering Department, College of Technological Studies
Public Authority of Applied Education and Training, Kuwait
rk.dib@paaet.edu.kw

³Electrical and Computer Engineering
National University of Singapore, Singapore
elemfk@nus.edu.sg

Abstract — In this paper, a switchable multiband monopole composite right/left-handed (CRLH) antenna is designed, fabricated and measured. The structure consists of a monopole loaded with three CRLH unit cells. By incorporating the three unit cells it aids in generating multiband frequencies. The switchable antenna is developed by placing the pin diodes which enables the simultaneous operation of unit cells. A detailed parametric study is done to investigate the influence and the effect of CRLH cells dimensions. The simulation and measured results are in good agreement. The results show multiple bands from 1-4 GHz. The measured maximum gain of antenna is 3.13 dBi.

Index Terms — CRLH, metamaterials, monopole antenna, multiband, switchable.

I. INTRODUCTION

Reconfigurability of an antenna is a characteristic that can enhance the capability and versatility of antenna in certain applications. The switchable is applicable to the frequency of operation or the variation in the direction of the main beam beamwidth. In frequency-switchable antennas, the frequency of operation can be electronically tuned with the aid of microelectromechanical system (MEMS), or solid-state devices like varactor diodes and switching p-i-n diodes [1]-[5].

Switchable antennas enables a narrowband alternative to wideband antennas in communication systems where a single antenna has to be used for radio communication in different frequency bands. The other feature of these antennas is that, as the bandwidth is inversely related to the size of the antenna by fundamental limits, a smaller resonant antenna can cover a broad frequency range. In addition, the underlying band selectiveness can relax the filtering requirements for the radio system connected to

the antenna. Patch antenna, planar inverted-F antennas (PIFAs), and slot antennas have shown great capability for switchable frequency antennas [1]-[7]. Recently, antennas have been loaded with metamaterial cells which can provide simultaneous negative electric permittivity and negative magnetic permeability. Such unit cells can be used to reduce the operating frequency significantly and to provide multifrequency operation [8]-[15].

A conventional resonant-type antennas are loaded with composite right/left-handed (CRLH) unit cells, this allows it to operate at the zeroth-order mode or negative-order modes. These types of techniques were demonstrated for the dipole antenna [9], patch antenna [10]-[12], and slot antenna [13]. In another type, conventional antennas are either electrically or magnetically coupled to metamaterial cells [14], [15]. CRLH cells help to reduce the operating frequency.

In this paper, a new microstrip-fed multiband monopole switchable antenna loaded with three CRLH unit cells. The antenna is designed to work at multiple bands of operation. The three CRLH cells are connected through p-i-n diodes. Each CRLH cells has its own characteristics of operation. A parametric study is done to investigate the influence and the effect of CRLH cells dimensions. The measurements of the S-parameters were performed using PNA series network analyzer, Agilent E8364B. The numerical simulations are carried out using CST (Computer Simulation Technology) Microwave Studio 2012 and MATLAB 2012.

II. DESIGN OF THE SWITCHABLE MULTIBAND MONOPOLE CRLH ANTENNA

The switchable monopole CRLH antenna is shown

in Fig. 1. The dimension of the ground plane is pertinent to determine the radiation pattern and also the operating bandwidth of the antenna. In our case, the monopole length was designed to operate around 2.4 GHz on Rogers 4003 with substrate thickness of 0.8 mm and dielectric constant equal to 3.38. The dimensions are given in Table 1. A diode is placed between every consecutive CRLH cells. The diodes are controlled by the bias-circuit to vary the number of the connected cells. Switching OFF the diodes will lead to a single CRLH cell, whereas switching ON the diodes will connect the other cells to the proposed antenna as shown in Fig. 1.

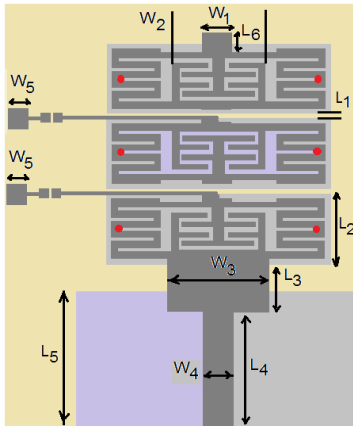

Fig. 1. Structure of switchable CRLH monopole antenna (not to scale).

Table 1: Dimensions of the CRLH antenna

Symbol	Length in (mm)
L_1	0.4
L_2	7
L_3	15.5
L_4	55
L_5	55
L_6	1.5
W_1	3
W_2	20
W_3	12
W_4	4.5
W_5	2
t_1	0.3
t_2	7
t_3	5.5
t_4	1.5
t_5	1
d	1
W_c	0.4
W_s	0.7
S_c	0.6
S_s	0.3

A. Design of a unit cell CRLH

The conventional CRLH unit cell is presented in [16]. It relies on the interdigital capacitor to provide the series capacitance and on the shunt short-circuited stub for the parallel inductance. There are three modifications made to the conventional unit cell as shown in Fig. 2. The major modification is that the unit cell is made symmetric so that even if the unit cell radiates, the radiation from the right side will cancel the radiation from the left side and the radiation-pattern will be controlled mainly by the monopole. The other change is that the capacitor is rotated to reduce its length in the lateral direction so that the unit cell occupies a small portion of the monopole. Moreover, short-circuited stubs are added before the interdigital capacitor to enhance the inductance of the unit cell. The upper and lower stubs are connected by one via to the ground to reduce the number of the required vias. It should be noted that the ground of the CRLH unit cell is not connected to the main ground of the microstrip-fed monopole. As presented in Table 1, the dimensions of the interdigital capacitor and the stub inductor are adjusted so that the CRLH unit cell is nearly balanced around 2.4 GHz on Rogers 4003. Figures 3 (a)-(b) demonstrates the simulation results of S_{11} , for the single CRLH cell and the three connected CRLH cells, respectively.

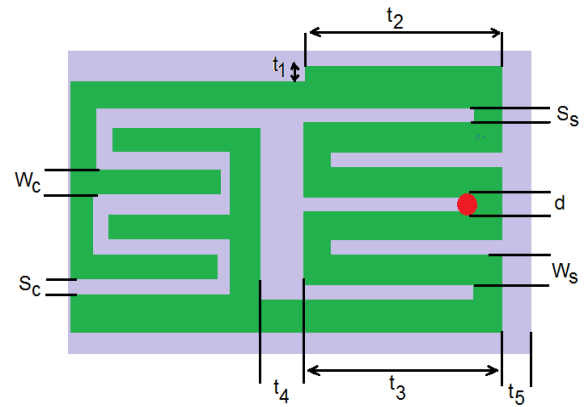

Fig. 2. Structure of a unit cell (not to scale).

B. Parametric variation of the slot width

In this subsection, the interdigital slot width, W_s , is varied to investigate the influence on the performance of antenna. As depicted in the Fig. 4, the slot width varies from 0.5 mm to 0.7 mm. Due to the fabrication tolerance limits, the slot width cannot be furtherly reduced. The operating frequency is slightly shifted to lower frequency with the increase in the slot width. The gain with frequency plot depicts that the 0.6 gives the maximum and stable gain over the frequency range from 0.5 GHz to 4 GHz as shown in Fig. 5.

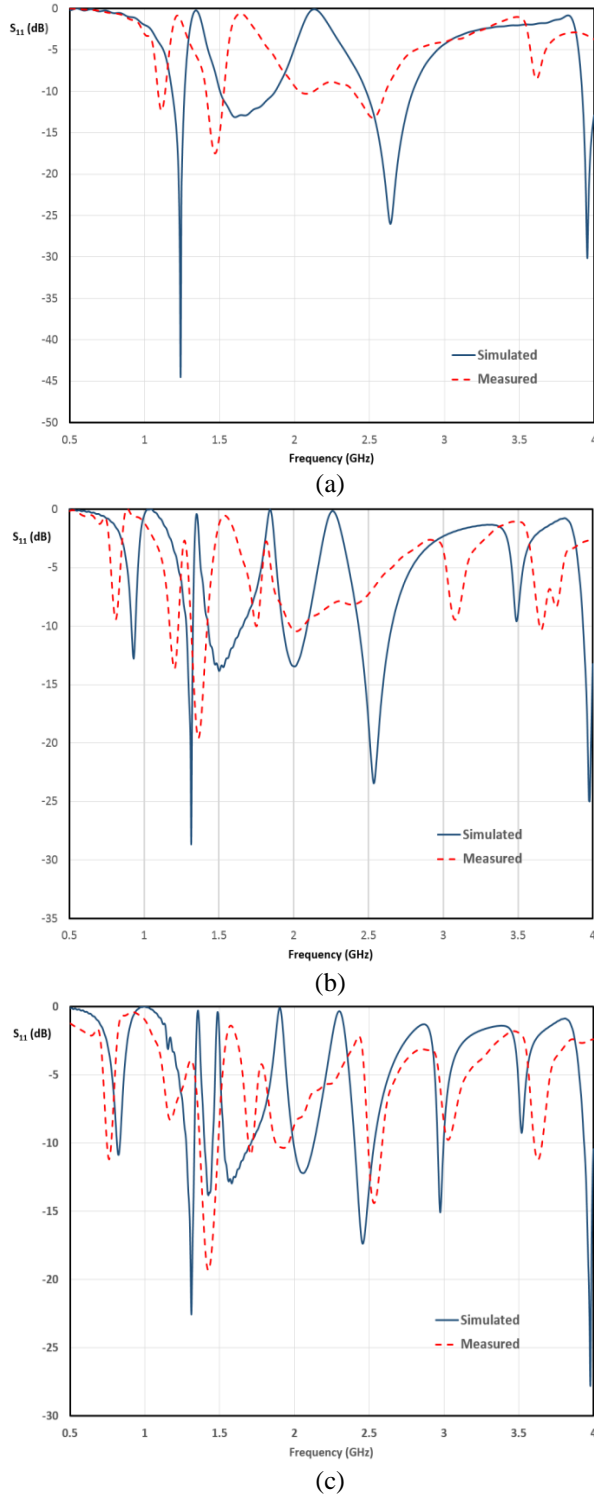

Fig. 3. Measured and simulation results of S_{11} : (a) single CRLH cell, (b) two CRLH cells, and (c) three CRLH cells.

C. Varying the number of CRLH cells

The number of CRLH cells has a significant influence on the performance of the antenna. A unit cell configuration was studied in the previous section. The increase in the number of CRLH cells generates the multiband configuration. The frequency shifts to lower frequency as the number of CRLH cells increase. The shift in the frequency for the first resonance is 0.7 GHz when compared to a unit cell CRLH. Moreover, there are seven operating bands within 1-3 GHz as shown in Fig. 6. In Fig. 7, the result for the gain plot signifies a constant gain of over 1.5 dBi. The maximum gain of 4.5 dBi is centered at 2.6 GHz.

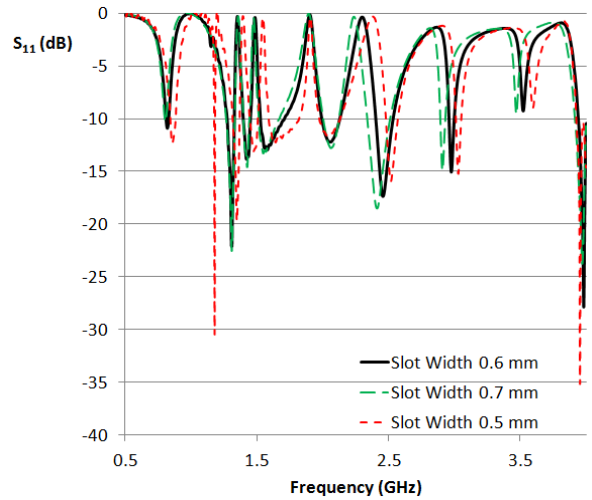

Fig. 4. Simulated plot for S_{11} at different slot widths.

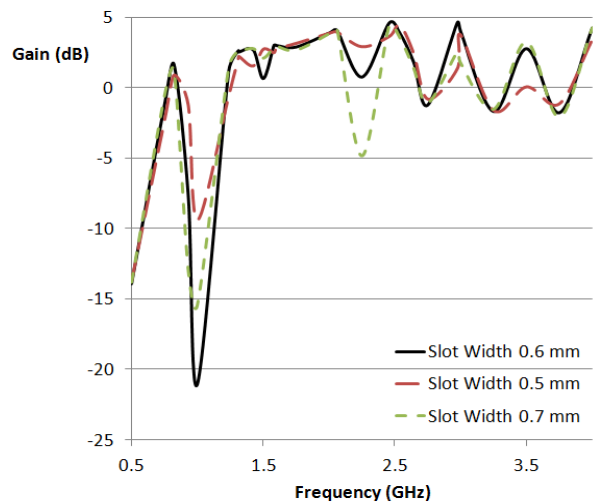

Fig. 5. Simulated plot for gain variation at different slot widths.

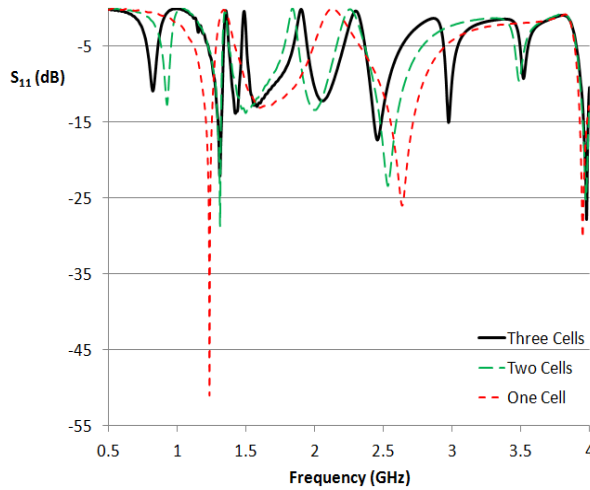

Fig. 6. Simulated plot of S_{11} for single, two, and three CRLH cells antenna.

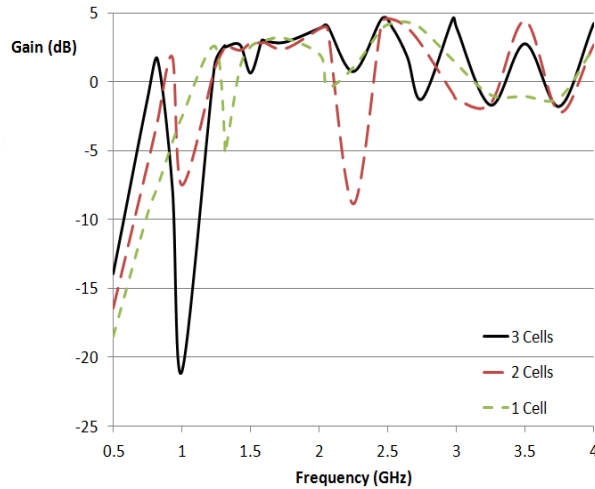

Fig. 7. Simulated plot of gain variation for single, two, and three CRLH cells antenna.

III. MEASURED RESULTS AND DISCUSSION

The CRLH switchable antenna is fabricated on Rogers 4003 substrate with 0.8 mm thickness. Table 1 shows the optimized dimensions. The fabricated switchable three CRLH cells antenna structure is shown in Fig. 8. The pin diodes are used to switch between the cells. A separate DC bias line is drawn to provide voltage for the operation of the diodes. The measured S_{11} for the switchable monopole CRLH antenna is shown in Fig. 9. When the pin diodes D1 and D2 are switched OFF, only single unit cell CRLH is connected to the monopole antenna. By connecting the second CRLH cell to the monopole antenna when the first diode, D1 is switched ON, resulting into two CRLH cells antenna configuration. Consequently, by switching ON the second diode D2, the

third CRLH cell is connected to the monopole antenna. Results show the multiband characteristics of the antenna when all the three cells are radiating. Table 2 depicts the gains and the efficiencies of the three CRLH cells antenna at the seven corresponding resonant frequency bands.

Table 2: Simulation results of the three CRLH cells antenna at the resonant frequencies

Frequency (GHz)	Gain (dB)	Efficiency (%)
0.822	1.635	92.3
1.312	2.617	97.6
1.424	2.673	96.0
1.5815	2.987	95.9
2.061	4.044	93.9
2.4565	4.572	98.2
2.9745	4.594	96.7

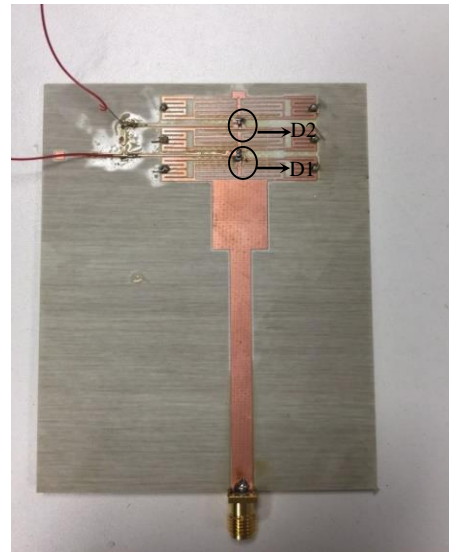

Fig. 8. Fabricated switchable monopole CRLH antenna.

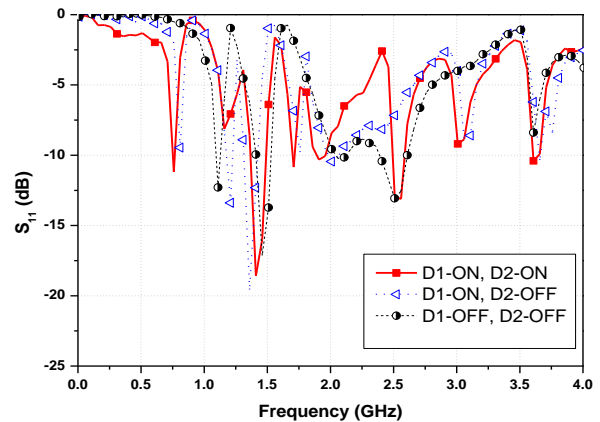

Fig. 9. Measured results for the switchable monopole CRLH antenna.

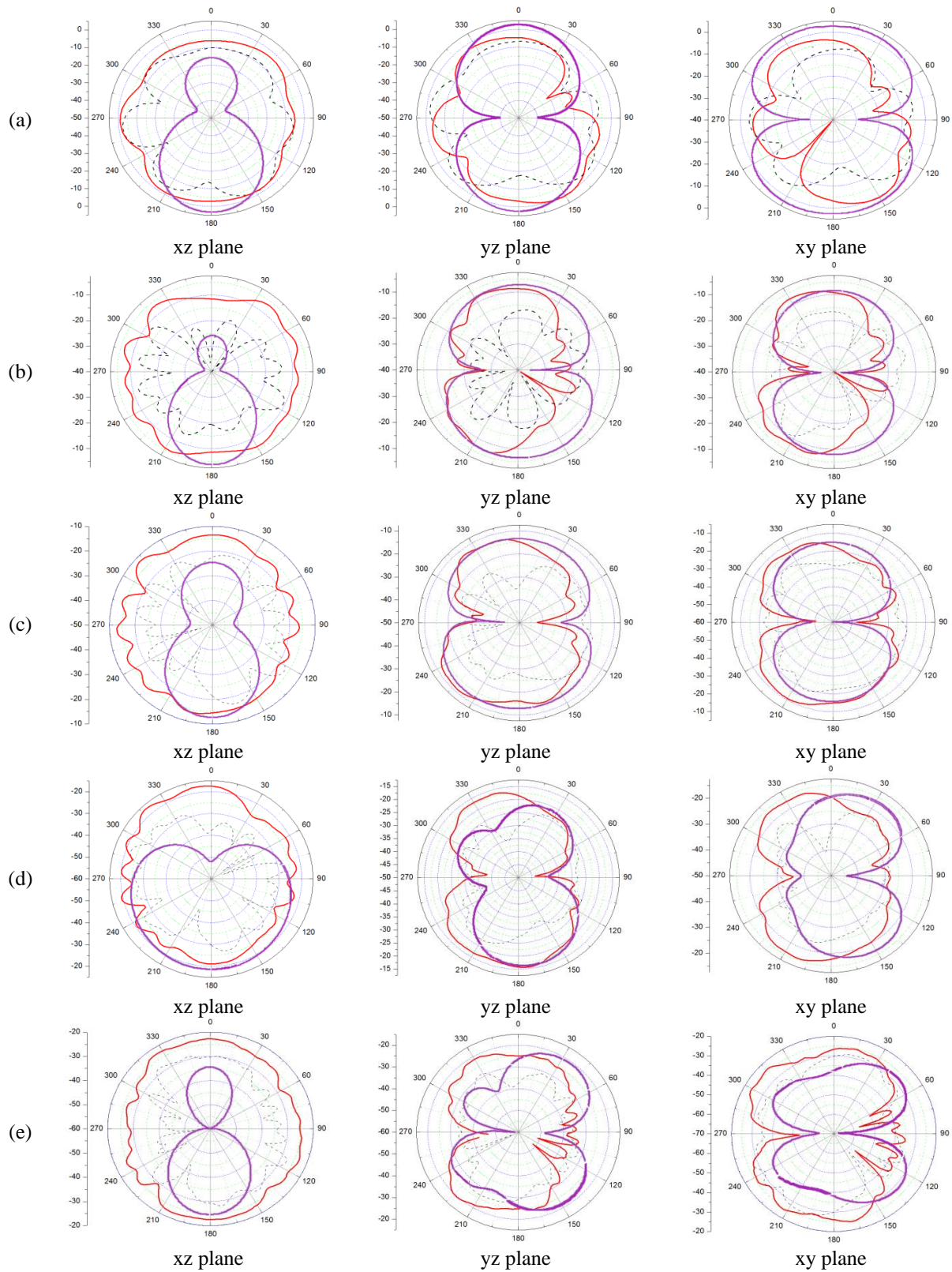

Fig. 10. Comparison between simulated (purple-line) and measured (red-line) radiation pattern for the three planes of the three CRLH antenna cells operated at the five resonance-frequencies: (a) $f = 0.76$ GHz, (b) $f = 1.41$ GHz, (c) $f = 1.71$ GHz, (d) $f = 1.91$ GHz, and (e) $f = 2.55$ GHz.

The simulated radiation patterns which are quasi-omni-directional at the seven operating frequency bands are illustrated in Fig. 10 (purple-line). Note that the radiation patterns of the three CRLH cells are consistent with the conventional microstrip-fed monopole antenna presented in [17], except the last two at the resonance frequency of 2.9745 GHz. The measured radiation patterns for the switchable monopole CRLH antenna are shown in Fig. 10 (red-line). It operates at 5 different frequency bands and depicts a monopole pattern. The measured maximum gain of antenna is 3.13 dBi.

The comparison study of the radiation pattern for the three planes of the three CRLH antenna cells operated at the five resonance-frequencies presented in Fig. 10 shows that the simulated and measured results are in good agreement.

IV. CONCLUSION

A switchable multiband monopole composite right/left-handed (CRLH) antenna was proposed. The antenna principle of operation was explained, and a prototype was designed and measured. The structure consists of a monopole loaded with three CRLH unit cells. The switchable antenna was developed by placing the pin diodes which enables the simultaneous operation of unit cells. The simulation and measured results are in good agreement. The results show multiple bands from 1-4 GHz. The measured maximum gain of antenna is 3.13 dBi.

REFERENCES

- [1] S. V. Hum and H. Y. Xiong, "Analysis and design of a differentially-fed frequency agile microstrip patch antenna," *IEEE Trans. Antennas Propag.*, vol. 58, no. 10, pp. 3122-3130, Oct. 2010.
- [2] V.-A. Nguyen, R.-A. Bhatti, and S.-O. Park, "A simple PIFA-based tunable internal antenna for personal communication handsets," *IEEE Antennas Wireless Propag. Lett.*, vol. 7, pp. 130-133, 2008.
- [3] N. Behdad and K. Sarabandi, "Dual-band reconfigurable antenna with a very wide tunability range," *IEEE Trans. Antennas Propag.*, vol. 54, no. 2, pp. 409-416, Feb. 2006.
- [4] C. R. White and G. M. Rebeiz, "Single-and dual-polarized tunable slot-ring antennas," *IEEE Trans. Antennas Propag.*, vol. 57, no. 1, pp. 19-26, Jan. 2009.
- [5] H. Li, J. Xiong, Y. Yu, and S. He, "A simple compact reconfigurable slot antenna with a very wide tuning range," *IEEE Trans. Antennas Propag.*, vol. 58, no. 11, pp. 3725-3728, Nov. 2010.
- [6] J. L. A. Quijano and G. Vecchi, "Optimization of an innovative type of compact frequency-reconfigurable antenna," *IEEE Trans. Antennas Propag.*, vol. 57, no. 1, pp. 9-18, Jan. 2009.
- [7] M. Komulainen, M. Berg, H. Jantunen, E. T. Salonen, and C. Free, "A frequency tuning method for a planar inverted-F antenna," *IEEE Trans. Antennas Propag.*, vol. 56, no. 4, pp. 944-950, Apr. 2008.
- [8] M. Palandoken, A. Grede, and H. Henke, "Broadband microstrip antenna with left-handed metamaterials," *IEEE Trans. Antennas Propag.*, vol. 57, no. 2, pp. 331-338, Feb. 2009.
- [9] H. Iizuk and P. S. Hall, "Left-handed dipole antennas and their implementations," *IEEE Trans. Antennas Propag.*, vol. 55, no. 5, pp. 1246-1253, May 2007.
- [10] C.-J. Lee, K. M. K. H. Leong, and T. Itoh, "Composite right/left-handed transmission line based compact resonant antennas for RF module integration," *IEEE Trans. Antennas Propag.*, vol. 54, no. 8, pp. 2283-2291, Aug. 2006.
- [11] F. J. Herraiz-Martínez, V. González-Posadas, L. García-Muñoz, and D. Segovia-Vargas, "Multi-frequency and dual-mode antennas partially filled with left-handed structures," *IEEE Trans. Antennas Propag.*, vol. 56, no. 8, pp. 2527-2539, Aug. 2008.
- [12] M. Schüßler, J. Freese, and R. Jakoby, "Design of compact planar antennas using LH transmission lines," in Proc. *IEEE MTT-S Int. Microw. Symp.*, vol. 1, pp. 209-212, Jun. 2004.
- [13] P. B. Nesbitt and G. Mumcu, "A small slot dipole loaded with CRLH TL unit cells," *IEEE AP-S Int. Symp. Dig.*, pp. 1032-1035, Jul. 2011.
- [14] A. Erentok and R. W. Ziolkowski, "Metamaterial-inspired efficient electrically-small antennas," *IEEE Trans. Antennas Propag.*, vol. 56, no. 3, pp. 691-707, Mar. 2008.
- [15] J. Zhu, M. A. Antoniades, and G. V. Eleftheriades, "A compact tri-band monopole antenna with single-cell metamaterial loading," *IEEE Trans. Antennas Propag.*, vol. 58, no. 4, pp. 1031-1038, Apr. 2010.
- [16] C. Caloz and T. Itoh, *Electromagnetic Metamaterials: Transmission Line Theory and Microwave Applications*, Hoboken, NJ: Wiley Interscience, 2006.
- [17] M. J. Ammann and M. John, "Optimum design of the printed strip monopole," *IEEE Antennas Propag. Mag.*, vol. 47, no. 6, pp. 59-61, Dec. 2005.



Abdullah K. Alqallaf received the B.S. and M.S. degrees in Electrical Engineering from Kuwait University in 1996 and 1999, respectively, and the Ph.D. degree in Electrical Engineering from the University of Minnesota – Twin Cities, St. Paul, MN, in 2009. He is an Assistant

Professor with the Department of Electrical Engineering at the Kuwait University. Alqallaf's research interests are Microwave Imaging Techniques, Multimedia Signal Processing, Communication, Bioinformatics and Medical Image Analysis. Alqallaf is an IEEE Board Member - Professional Activities - Kuwait Section.



Rabie K. Dib received the B.S. and M.S. degrees in Electrical Engineering from Kuwait University in 1999 and 2002, respectively. He is an Instructor with the Electronics Engineering Dept., College of Technological Studies at Public Authority of Applied Education and Training, Kuwait. Dib's research interests are Electromagnetics, Communication, Antenna Design, Microwave Imaging Techniques and analysis.



Muhammad Faeyz Karim received his Ph.D. and M.Sc. degrees in 2008 and 2003 from Nanyang Technological University (NTU), Singapore and B.Eng. from NUST, Pakistan in 2000. Karim has published more than 50 scientific papers in reputable international journals and conferences. He has co-authored a book on

"RF MEMS Switches and Integrated Switching Circuits", Springer, USA, 2010. He received the best paper award in Asia-Pacific Conference of Transducers and Micro-Nano Technology in 2003. He was involved in organizing the Microwave Photonics Conference (MWP), 2011 and IEEE IMWS Conference 2013 in Singapore, served as TPC Member for IEEE RFIT2009 & RFIT 2011, Session chairs for number of conferences and Reviewers for IEEE Transactions on MTT/AP, IEEE MWCL and IET MAP. His current research interests are in the area of RF & millimeter wave for RF MEMS devices, active/passive millimeter wave sensing and imaging systems, RF & hybrid energy harvesting, RF Nanoelectronics, tunable & reconfigurable filters, antenna miniaturization techniques, passives modules & circuits, and radio-over-fiber technologies.