

Wideband Filtering Crossover Based on Ring Resonator with Sharp Rejection

Wanchen Yang^{1,2}, Wenjie Feng^{1,2*}, and Wenquan Che¹

¹Department of Communication Engineering, Nanjing University of Science & Technology, Nanjing, China

²State Key Laboratory of Millimeter Waves, Southeast University, Nanjing, China
fengwenjie1985@163.com

Abstract — A wideband filtering crossover based on ring resonators with sharp rejection is proposed in this paper. Four transmission zeros near the crossover passband can be adjusted conveniently by the even/odd-mode characteristic impedance of the coupled lines. A high selectivity wideband filtering crossover located at 3.0 GHz is designed and fabricated for verification. Good filtering performance and high selectivity for the crossover are realized and experimentally verified.

Index Terms — Coupled lines, even/odd-mode, filtering crossover, transmission zero, wideband.

I. INTRODUCTION

Crossover is a very important component and can be integrated in Butler matrix, which exhibits two signal paths crossing over each other with perfect isolation and all ports matched. Air-bridge and bond-wire are always used to transport signals in different layers for conventional crossovers [1]-[2], resulting in complex structures and relatively high fabrication cost. Cascaded rings and branch-lines couplers are used to overcome these drawbacks [3]-[5]; however, multi-section rings and couplers enlarge the circuit size and the transmission insertion loss. The conductor-backed coupling lines can be used to realize wideband crossovers [6], which can avoid using cascaded structures. Moreover, microwave passive components including crossovers, filters, and couplers are always single elements, integrating two functions in one component is an effective method for size reduction, such as filtering balanced circuits [7] and filtering crossovers [8].

In this paper, a wideband filtering crossover with sharp rejection is proposed. Four transmission zeros for the crossover passband with good isolation performance over a very wide frequency range can be realized [9]-[10]. Using coupled lines and open stubs with different electrical wavelength, fifth-order passband can be easily achieved for the planar crossover. The desired crossover configuration can be obtained using even/odd-mode characteristic impedance of the coupled lines and characteristic impedance of the open stubs. A wideband

filtering crossover located at 3.0 GHz with 3-dB bandwidth 26.3% (2.58-3.37 GHz) is designed and fabricated for verification. All the circuits and structures are simulated with Ansoft Designer v3.0 and Ansoft HFSS v13.0, and constructed on the dielectric substrate with $\epsilon_r = 2.65$, $h = 1.0$ mm, and $\tan\delta = 0.003$.

II. DESIGN OF PROPOSED WIDEBAND CROSSOVER

Figure 1 shows an improved crossover based on dual-mode ring resonator [6], four quarter-wavelength side-coupled lines (electrical length θ , even/odd-mode characteristic impedance Z_{e1} , Z_{o1}) are attached to the four input/output ports. Four microstrip lines with characteristic impedance $Z_0 = 50 \Omega$ are connected to Ports 1 to 4. Due to the symmetry of the single-band crossover, the even-odd-mode analysis is employed to simplify the analysis and to derive the impedance values [1]-[6], which are required to meet the following properties:

$$\begin{aligned} |S_{11}| = |S_{22}| = |S_{33}| = |S_{44}| = 0, \\ |S_{21}| = |S_{23}| = |S_{41}| = 0, |S_{31}| = |S_{24}| = 1. \end{aligned} \quad (1)$$

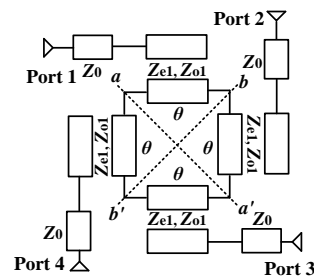

Fig. 1. Ideal circuit of the improved crossover based on ring resonator [6].

By placing electric wall (*E*-wall) and *E*-wall, magnetic wall (*H*-wall) and *H*-wall, *E*-wall and *H*-wall, *H*-wall, and *E*-wall along the symmetry lines *a-a'* and *b-b'*, respectively, as shown in Figs. 2 (a)-(d); four even/odd eigen-admittances Y_{ee} , Y_{eo} , Y_{oe} , Y_{oo} can be required [6]:

$$Y_{ee} = j \frac{2 \tan \theta}{Z_{e1} + Z_{o1}}, Y_{eo} = -j \frac{2(Z_{e1} + Z_{o1}) \tan \theta}{(Z_{e1} - Z_{o1})^2 \tan^2 \theta - 4Z_{e1}Z_{o1}}, \quad (2)$$

$$Y_{oe} = j \frac{2(Z_{e1} + Z_{o1}) \tan \theta}{Z_{e1}Z_{o1}}, Y_{oo} = j \frac{2(Z_{e1} + Z_{o1}) \tan \theta}{Z_{e1}Z_{o1}}. \quad (3)$$

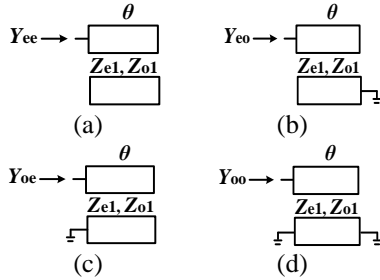

Fig. 2. Decomposed equivalent circuits of the crossover based on ring resonator: (a) even–even-mode circuit; (b) even–odd-mode circuit; (c) odd–even-mode circuit; (d) odd–odd-mode circuit.

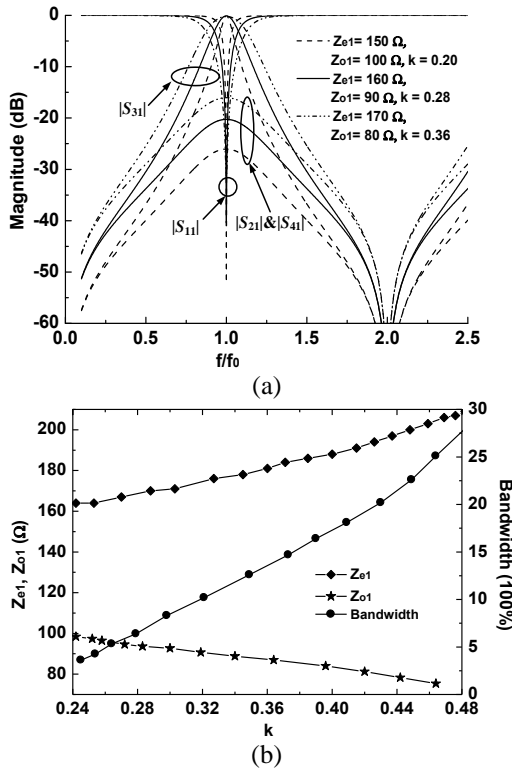

Fig. 3. (a) Simulated results of the crossover based on ring resonator, and (b) bandwidth versus coupling coefficient k .

After further calculation, we find that different combinations of design values that can be used to realize a broadband performance for the crossover. Figures 3

(a)-(b) show the simulated results of the crossover based on ring resonator versus Z_{e1} , Z_{o1} , and the bandwidth of the crossover increases with the coupling coefficient k increases ($k = (Z_{e1}-Z_{o1})/(Z_{e1}+Z_{o1})$), and the isolation between Ports 1 to 2, and 4 become worse as k increases. Due to the PCB fabrication precisions, the width for the transmission lines and coupled lines are always greater than 0.20 mm, so the maximum coupling coefficient k of the coupling lines in this work is nearly 0.45 ($\epsilon_r = 2.65$, $h = 1.0$ mm), and the characteristic impedance of the transmission lines is always less than 130 Ω , so the bandwidth of the crossover cannot increase infinitely.

The ideal circuit of the proposed wideband filtering crossover is shown in Fig. 4, a two-stage coupling line is used to increase the bandwidth for Fig. 1, and four half-wavelength open stubs (electrical length 2θ , characteristic impedance Z_1) are attached in the input coupled lines, and four open/shorted coupled lines (Z_{e2} , Z_{o2} , θ) are shunted connected in the input/output Ports 1 to 4. As discussed in [7], [9], four transmission zeros realized by the half-wavelength open stubs and open/shorted coupled lines can be obtained as:

$$\theta_{tz1} = \pi / 4, \quad \theta_{tz2} = 3\pi / 4, \quad (4)$$

$$\theta_{tz3} = \arccos \frac{Z_{e2} - Z_{o2}}{Z_{e2} + Z_{o2}}, \quad \theta_{tz4} = \pi - \theta_{tz3}. \quad (5)$$

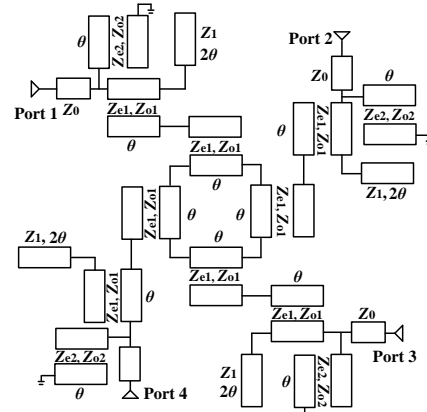

Fig. 4. Proposed wideband filtering crossover based on ring resonator.

The half-wavelength open stubs are all wide passband structures [11], they can be seen as an ideal open circuit in the center frequency of the crossover. In addition, we can find that two transmission zeros f_{tz3} , f_{tz4} don't change with Z_1 , Z_{e1} , and Z_{o1} , so when the even/odd-mode characteristic impedance Z_{e1} , Z_{o1} are fixed, the bandwidth of the wideband crossover can be adjusted by the characteristic impedance of the open stubs Z_1 , and the out-of-band performance of the crossover can be further improved by the two transmission zeros f_{tz3} , f_{tz4} . The simulated results of the wideband filtering crossover with/without four transmission zeros are shown in Figs.

5 (a)-(c). The passband order can be increased from third to fifth, and four transmission zeros can be used to realize a wide passband for the crossover with sharp rejection, the two transmission zeros f_{tz3} , f_{tz4} nearly do not change the bandwidth of the wideband filtering crossover, and the in-band performance can be also adjusted by the characteristic impedance Z_1 of the four half-wavelength open stubs.

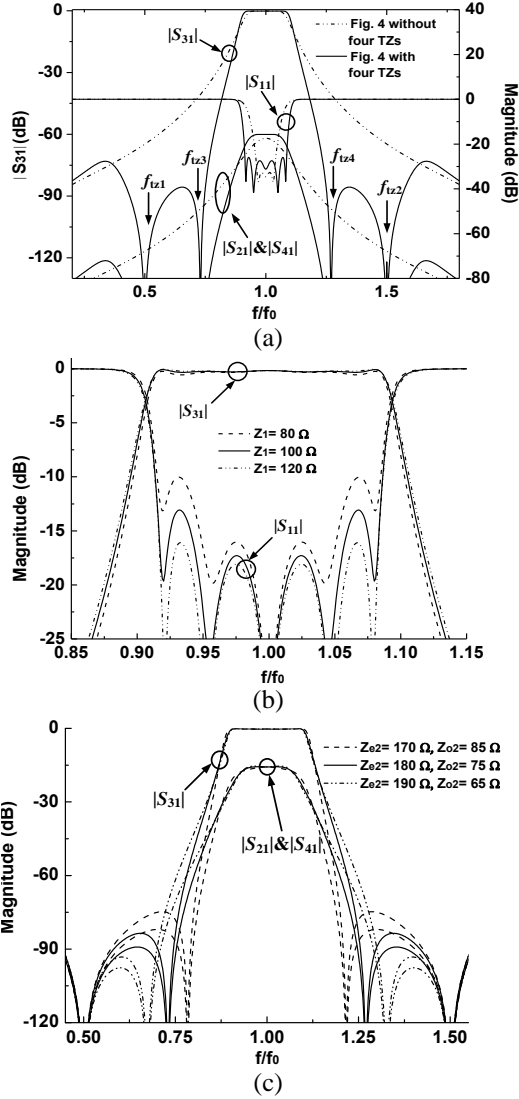

Fig. 5. Simulated results of the wideband filtering crossover. (a) With/without transmission zeros, (b) $|S_{31}|$, $|S_{11}|$ versus Z_1 , and (c) $|S_{31}|$, $|S_{21}|$ versus Z_{e2} , Z_{o2} . ($Z_0 = 50 \Omega$, $Z_1 = 120 \Omega$, $Z_{e1} = 170 \Omega$, $Z_{o1} = 108 \Omega$, $Z_{e2} = 180 \Omega$, $Z_{o2} = 75 \Omega$).

Referring to the discussions and the simulated results, the 3-dB bandwidth of the filtering crossover is chosen as 26%, and the final parameters for Fig. 4 are $Z_0 = 50 \Omega$, $Z_{e1} = 175 \Omega$, $Z_{o1} = 112 \Omega$, $Z_1 = 125 \Omega$. The simulated results

of Fig. 6 are illustrated in Fig. 7, and five transmission zeros are located at 1.5, 2.0, 2.2, 3.6 and 4.5 GHz, the passband $|S_{31}|$ is greater than -1.2 dB, the isolation $|S_{21}|$ and $|S_{41}|$ are less than -18 dB for 0~10.0 GHz.

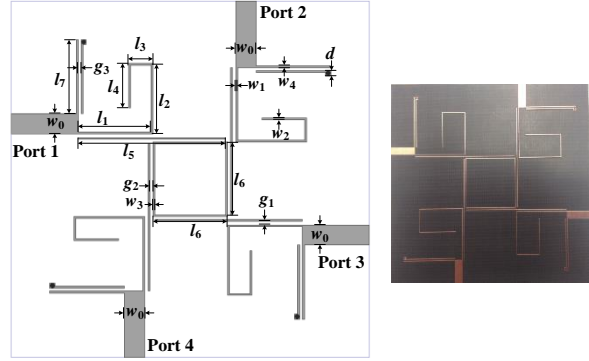

Fig. 6. Geometry of the wideband filtering crossover. ($l_1 = 18.0$, $l_2 = 15.5$, $l_3 = 8.45$, $l_4 = 13.0$, $l_5 = 36.3$, $l_6 = 18.25$, $l_7 = 18.25$, $w_0 = 2.7$, $w_1 = 0.24$, $w_2 = 0.27$, $w_3 = 0.23$, $w_4 = 0.3$, $g_1 = g_2 = 0.45$, $g_3 = 0.35$, $d = 0.6$, all in mm).

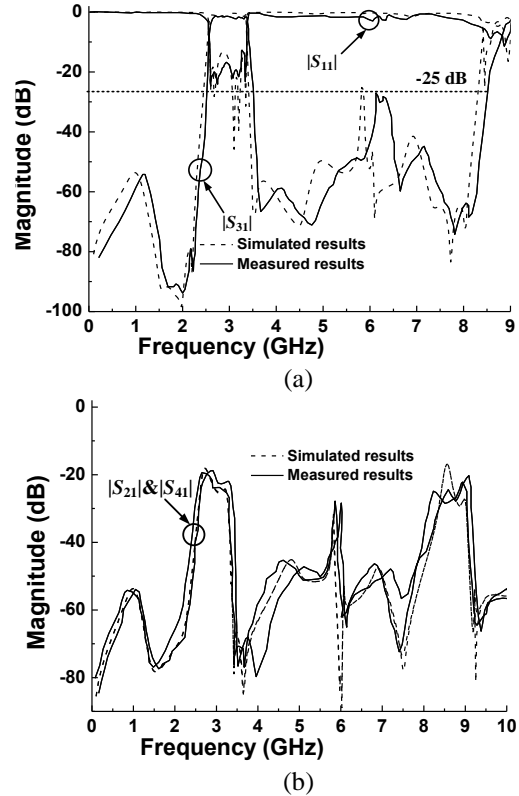

Fig. 7. Simulated and measured results of the crossover. (a) $|S_{31}|$, $|S_{11}|$, and (b) $|S_{21}|$, $|S_{41}|$.

III. EXPERIMENT AND RESULTS

The photograph, measured results of the wideband crossovers are also shown in Figs. 6-7. For the wideband

crossover, five measured transmission zeros are located at 1.6, 2.0, 2.3, 3.5 and 4.7 GHz, the 3-dB bandwidth is 26.3% (2.58-3.37), the in-band $|S_{31}|$ is greater than -2.3 dB, the isolation $|S_{21}|$ and $|S_{41}|$ are less than -18.5 dB for 0~10.0 GHz ($3.3f_0$).

For the purpose of comparison, Table 1 illustrates the measured results for some crossovers with proposed wideband filtering crossover. It can be seen that, the proposed filtering crossover has wideband isolation for $|S_{21}|$ and $|S_{41}|$, and the upper stopband for $|S_{31}|$ can be extended up to $2.8f_0$ ($|S_{31}| < -25$ dB), and further circuit size reduction can be also realized by using folded lines in multi-layer circuits.

Table 1: Comparisons of measured results for some crossovers

Crossover Structures	TZs, $ S_{31} $ 0- $2f_0$	Isolation $ S_{21} / S_{41} $, dB	Stopband $ S_{31} $, dB	Filtering Response
Ref. [3]	0 (1.0 GHz)	25%, <-20	<-10, $1.50f_0$	No
Ref. [4]	0 (2.5 GHz)	14.0%, <-20	---	No
Ref. [6]	0 (2.5 GHz)	200%, <-12	---	No
Ref. [8]	4 (2.0 GHz)	100%, <-20	<-25, $2.50f_0$	Yes
This work	5 (3.0 GHz)	330%, <-19	<-25, $2.80f_0$	Yes

IV. CONCLUSIONS

In this paper, a wideband filtering crossover with sharp rejection based on ring resonator is proposed, four transmission zeros can be easily realized by the adding open stubs and open/shorted coupled lines. The proposed wideband filtering crossover has advantages of high selectivity, wide stopband and wideband. Good agreements between simulated and measured responses of the structures are demonstrated.

ACKNOWLEDGEMENT

This work was supported by the Natural Science Foundation of China (61601224) and Jiangsu Province (BK20160844), and in part by the Fundamental Research Funds for the Central Universities of China under Grant 30916011318, and the Open Funding of State Key Laboratory of Millimeter Waves (K201721, K201804) and "Qing Lan Project" of Jiangsu Province (2017-2020).

REFERENCES

- [1] T. Becks and I. Wolff, "Analysis of 3-D metalization structures by a full-wave spectral domain technique," *IEEE Trans. Microw. Theory Techn.*, vol. 40, no. 12, pp. 2219-2227, Dec. 1992.
- [2] W. Feng, T. Zhang, W. Che, and Q. Xue, "Compact single/dual-band planar crossovers based on coupled lines loaded with open stubs," *IEEE Trans. Compon. Packag. Manuf. Technol.*, vol. 60, no. 6, pp. 854-862, June 2016.
- [3] Y. C. Chiou, J. T. Kuo, and H. R. Lee, "Design of compact symmetric four-port crossover junction,"

IEEE Microw. Wireless Compon. Lett., vol. 19, no. 9, pp. 545-547, Sep. 2009.

- [4] J. J. Yao, C. Lee, and S. P. Yeo, "Microstrip branch-line couplers for crossover application," *IEEE Trans. Microw. Theory Techn.*, vol. 59, no. 1, pp. 87-92, Jan. 2011.
- [5] Y. L. Wu, L. X. Jiao, Z. Zhuang, and Y. Liu, "The art of power dividing: a review for state-of-the-art planar power dividers," *China Communications*, vol. 14, no. 5, pp. 1-16, May 2017.
- [6] H. Zhu, Y. Wang, and A. M. Abbosh, "Broadband microwave crossover using parallel coupled microstrip lines and short-ended stubs," *IET Microw. Antennas Propag.*, vol. 9, no. 1, pp. 79-85, Feb. 2014.
- [7] W. J. Feng, W. Q. Che, and Q. Xue, "Balanced filters with wideband common mode suppression using dual-mode ring resonators," *IEEE Trans. Circuits Syst. I: Regular Papers*, vol. 62, no. 6, pp. 1499-1507, June 2015.
- [8] X. Y. Zhang, Q. Y. Guo, K. X. Wang, B. J. Hu, and H. L. Zhang, "Compact filtering crossover using stub-loaded ring resonator," *IEEE Microw. Wireless Compon. Lett.*, vol. 24, no. 5, pp. 327-329, May 2014.
- [9] C. Zhao, W. Feng, and W. Che, "Ultra-wideband balanced bandpass filters based on transversal signal-interference concepts," *The Applied Computational Electromagnetics Society Journal*, vol. 30, no. 10, pp. 1232-1237, Oct. 2016.
- [10] X. Gao, W. Feng, and W. Che, "LTCC wideband bandpass filter based on multi-layered coupling," *The Applied Computational Electromagnetics Society Journal*, vol. 32, no. 2, pp. 158-162, Feb. 2017.
- [11] G. Matthaei, L. Young, and E. M. T. Jones, *Microwave Filters, Impedance Matching Networks and Coupling Structures*. Artech House Inc., Norwood, MA, Section 5, pp. 222-224, 1985.



Wanchen Yang was born in Xuzhou, Jiangsu Province, China, in 1988. She received the B. Eng. degree in Communication Engineering from the Hohai University (HHU), Nanjing, China, in 2010, and the Ph.D. degree in Electromagnetic Field and Microwave Technology from Nanjing University of Science and Technology (NUST), Nanjing, China, in 2015. From October 2013 to April 2014, she was a Research Assistant with the University of Macau. She was the recipient of the Best Paper Prize of 2014 Student Paper Competition in IEEE

HK AP/MTT Postgraduate Conference, Oct. 2014. She is currently a Teacher with Nanjing University of Science and Technology, Nanjing, China. Her main research interests include novel artificial materials, artificial material-based antennas and millimeter-wave antenna arrays.

She serves as a Reviewer of the IEEE Transactions on Microwave Theory and Techniques, IEEE Transactions on Industrial Electronics, IEEE Antennas and Wireless Propagation Letters and IET Microwaves Antennas and Propagation.



Wenjie Feng was born in Shangqiu, Henan Province, China, in 1985. He received the B.Sc. degree from the First Aeronautic College of the Airforce, Xinyang, China, in 2008, the M.Sc., and Ph.D. degrees from the Nanjing University of Science and Technology (NUST), Nanjing, China, in 2010, 2013.

From November 2009 to February 2010, March 2013 to September 2013, he was a Research Assistant with the City University of Hong Kong. From October 2010 to March 2011, he was an exchange student with the Institute of High-Frequency Engineering, Technische Universität München, Munich, Germany. He is currently a Professor with the Nanjing University of Science and Technology, Nanjing, China. He has authored or coauthored over 70 internationally referred journal and 50 conference papers. His research interests include wideband circuits and technologies, substrate integrated components and systems, multi-function circuits and systems, balanced circuits, LTCC circuits.

Feng is a Reviewer for over twenty internationally referred journal and conference papers, including five IEEE Transactions and five Letters. He now serves as an Associate Editor for *IET Electronics Letters*, *IEEE Access* and *International Journal of Electronics*.



Wenquan Che received the B.Sc. degree from the East China Institute of Science and Technology, Nanjing, China, in 1990, the M.Sc. degree from the Nanjing University of Science and Technology (NUST), Nanjing, China, in 1995, and the Ph.D. degree from the City University of Hong Kong (CITYU), Kowloon, Hong Kong, in 2003.

In 1999, she was a Research Assistant with the City University of Hong Kong. From March 2002 to September 2002, she was a Visiting Scholar with the Polytechnique de Montréal, Montréal, QC, Canada. She is currently a Professor with the Nanjing University of Science and Technology, Nanjing, China. From 2007 to 2008, she conducted academic research with the Institute of High Frequency Technology, Technische Universität München. During the summers of 2005–2006 and 2009–2012, she was with the City University of Hong Kong, as Research Fellow and Visiting Professor. She has authored or coauthored over 180 internationally referred journal papers and over 120 international conference papers. She has been a Reviewer for *IET Microwaves, Antennas and Propagation*. Her research interests include electromagnetic computation, planar/coplanar circuits and subsystems in RF/microwave frequency, microwave monolithic integrated circuits (MMICs) and medical application of microwave technology.

Che is a Reviewer for the IEEE Transactions on Microwave Theory and Techniques, IEEE Transactions on Antennas and Propagation, IEEE Transactions on Industrial Electronics, and IEEE Microwave and Wireless Components Letters. She was the recipient of the 2007 Humboldt Research Fellowship presented by the Alexander von Humboldt Foundation of Germany, the 5th China Young Female Scientists Award in 2008 and the recipient of Distinguished Young Scientist awarded by the National Natural Science Foundation Committee (NSFC) of China in 2012.