

Low RCS Antenna Design Using Genetic Algorithm Combined with Tabu List

Xinyue Zhu, Wei Shao, and Jia-Lin Li

School of Physical Electronics

University of Electronic Science and Technology of China, Chengdu 610054, P. R. China
zhuxinyue888@163.com, weishao@uestc.edu.cn, jialinuestc@yahoo.com.cn

Abstract — In this paper, a simple and efficient approach is presented to reduce the radar cross section (RCS) of patch antennas with defected ground structures (DGSs). This approach consists of an optimization algorithm, which combines a genetic algorithm (GA) with tabu list, and electromagnetic field solver. A tabu list, embedded into the GA frame, defines the acceptable neighborhood region of parameters and screens out the bad individuals. Thus, the repeats of search are avoided and the amount of electromagnetic simulation is largely reduced. Moreover, the whole design procedure is auto-controlled by programming the VBScript language. A patch antenna example is provided to verify the accuracy and efficiency of the proposed design method.

Index Terms — Genetic algorithm, patch antenna, RCS reduction, tabu list, VBScript.

I. INTRODUCTION

In order to avoid detection by radar, a low visibility platform is desired eagerly to a low radar cross section (RCS) for applications. An antenna that is a special scatterer has become an important contributor to the RCS [1]. The shaping method, including the slot structure [2], fractal geometry [3], frequency selective surface (FSS) [4] and defected ground structure (DGS) [5], is one of the most effective methods for antenna RCS reduction. Due to the tradeoff between antenna radiation and scattering requirements, it is very complex and time-consuming to design antenna with good radiation performance and low RCS. Therefore, a combination of the numerical algorithm and optimization method is needed to

complete this design.

The genetic algorithm (GA), a global search method modeled on the natural processes of genetic recombination and evolution, has been widely used for solving complex electromagnetic (EM) problems [6]. Using GAs, [7] optimizes the backscattering RCS patterns of a resistively loaded antenna. In [8], radar absorbing materials (RAMs) for RCS reduction in a wide-band frequency range is designed to obtain the best optimal composite coating with a GA optimization technique. To reduce the RCS of the cone and cylinder composite structure, a GA is adopted to optimize the anisotropic impedance object in a desired angle range [9]. However, all of these efforts focus on the scattering of objects, and it is not effective for the simultaneous consideration of antenna radiation and scattering performance.

In [10], a low RCS antenna design using the differential evolution algorithm (DEA) in conjunction with the method of moments (MoM) is presented. However, the final fitness calculations for each generation involve both of the radiation and scattering factors, which maybe lead to an inefficient solution. Later, lower RCS patch antennas are optimized by combining the GA with high frequency simulation software (HFSS) [11]. Although this approach saves the calculation time, some known individuals with bad radiation performance are still sent to be simulated in HFSS. In [12], a hybrid GA with the tabu list concept is proposed to increase the search efficiency of the algorithm. The algorithm is applied to reconstruct the shape of a metallic cavity based on the measurement data.

Instead of possessing quicker convergency in the traditional tabu search algorithm (TSA), the

tabu list in this paper is to define the information and features of individuals of bad radiation performance and avoid unnecessary scattering simulations for them. The new tabu list embedded into GA is introduced to design low RCS antennas. The GA is applied as the main frame because of its global ability of general search. All the individuals of a new generation produced by the GA will be sent to the proposed tabu list for comparison before they are simulated in HFSS. If the geometry parameters of an individual happen to not be in the acceptable neighborhood region, which is defined according to the individuals with acceptable radiation performances, the time-consuming simulation will not be conducted in HFSS for it. Thus, the amount of individuals which need to be simulated is reduced and it leads to an efficient low RCS antenna design. Moreover, an auto-controlled calculation is programmed based on the VBScript language in HFSS.

A DGS antenna with two rectangular slots on the patch is adopted as the prototype. For the low RCS antenna design, the geometry parameters of slots and DGS are optimized to obtain satisfying radiation and scattering performances. This example validates the feasibility and efficiency of the proposed approach.

II. HYBRID OPTIMIZATION ALGORITHM

A. Tabu list

The most important feature of the traditional tabu list is to prevent the revisiting of local minima in the parameter space. The tabu list in this paper is adopted to depict the features of individuals and decide the candidates to be simulated or not for the next step. The parameter information of individuals, which have important effect on the radiation performance of antennas, is evaluated by the tabu list. Each individual gets a score determined by a criterion to judge its quality. If the score is low, which means that the individual is not similar to the feature of bad individuals, it will be sent to HFSS simulation. If the score is high, parameters of the individual incorporate more bad features and it will not take time in conducting the simulation in HFSS for it.

The tabu list with the effect of parameters is established by pre-determination from HFSS. The score for each individual is given by

$$Score = \sum_i a_i |x_i - T_i|, i = 1, 2, 3, \dots \quad (1)$$

where a_i is the scale factor, x_i is the optimized parameter, and T_i is the corresponding threshold value that judges the parameter.

The bad property of population is defined by a reference score. If the reference score is set too low, the procedure will take more individuals as bad ones, which not only skips some better individuals but also runs easily into local optimum. If the reference score is set too high, fewer individuals are considered as bad ones, which means the tabu list does not work. So the reference score is necessary to be set appropriately.

B. Optimization for low RCS antennas

Figure 1 depicts the flowchart of the whole optimization and calculation process for a low RCS antenna. The process consists of the optimization module and HFSS simulation module which includes the radiation and scattering parts. The initialized population in this approach in Fig. 1 is the randomly created chromosomes. Each chromosome coded by a binary number represents an individual prototype of an antenna structure.

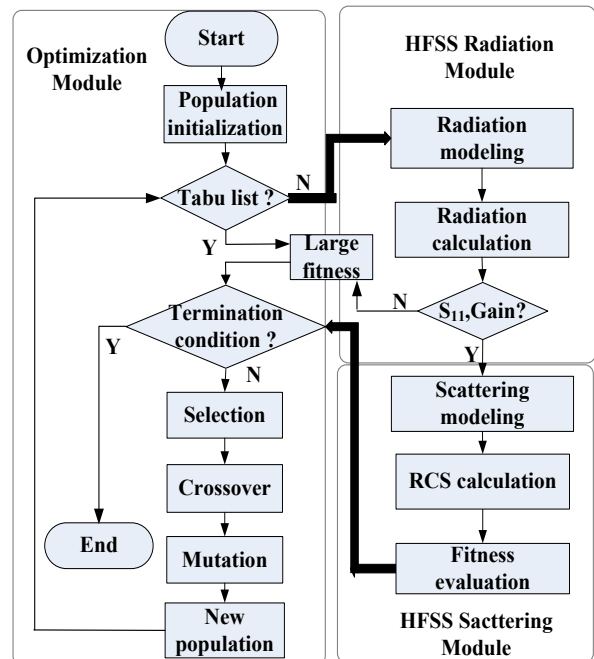

Fig. 1. Flowchart of the calculation for low RCS antenna design.

Firstly, parameters of each individual are evaluated by the tabu list. If the score is higher

than a given value, which means the individual satisfies the features of bad ones, its fitness value is set to a large number and it will not be sent to HFSS with simulation. The good individuals with small scores will be sent to be simulated in HFSS through the VBScript. Secondly, according to these parameters of good individuals, the antenna radiation models are established and calculated in HFSS. Thirdly, if the individuals meet the radiation requirements, such as S_{11} and gain conditions, their corresponding scattering models are established and fitness values are calculated. Otherwise, the fitness value is set to a large number and the scattering simulation is skipped. Thus, a waste of time to simulate scattering models of the worse individuals is avoided. Last, the fitness of each individual of the current generation is transferred to the GA and the parameters of individuals are optimized. The fitness function is defined as follows:

$$fitness = \sum_{j=1}^N \left(\frac{1}{n} \sum_{i=1}^n A_{RCS(i)} \right). \quad (2)$$

where n is the number of the RCS sample point versus frequencies, A_{RCS} is the RCS value of an individual antenna, and N represents for the different incident angles.

According to the results of the fitness evaluation, individuals are selected by the proportionate selection strategy. The selected individuals act as parents for a two-point crossover to rearrange the genes for producing better combinations of genes. Therefore, a new generation will have more fit individuals than the former one. In order to speed up the convergence of GA and reduce the time consuming of EM simulations, a certain amount of best individuals are saved and inserted into the new generation directly in the elitist strategy. Moreover, the tabu list reduces the time consuming of EM simulations, too. In order to avoid sticking at local optima, the mutation occurs with a low probability, of a value of 0.01 in this paper. After the GA produces a new generation, the individuals in the new population are evaluated by the tabu list and sent to HFSS for simulation again. The simulation and optimization are run alternatively until the termination condition is satisfied.

III. LOW RCS ANTENNA EXAMPLE

Various literatures have reported the antenna

design with DGSs. The effects of DGSs on antennas include the reduction of higher order harmonics [13], suppression of cross-polarized radiation [14], broaden impedance bandwidth [15], elimination of scan blindness [16] and mutual coupling suppression [17]. However, few literatures introduced the DGSs to the RCS reduction of antennas. In [5], a rectangular DGS is adopted to reduce the RCS at the expense of a 2.3dB gain decrease.

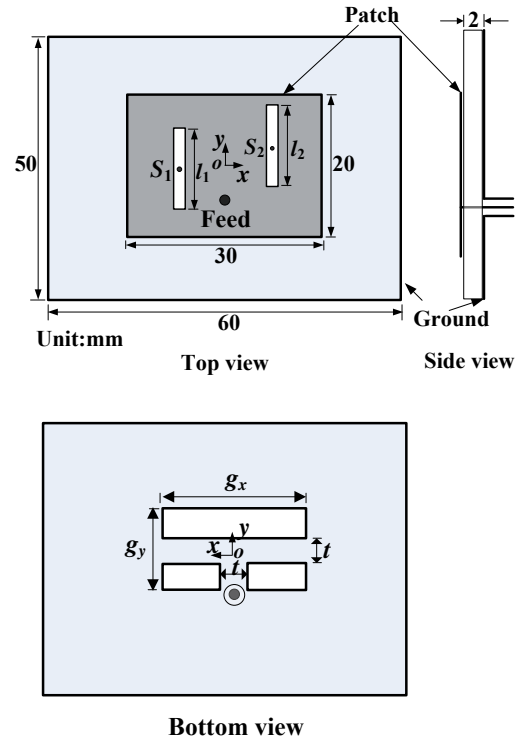

Fig. 2. Geometric structure of the optimized antenna.

In this paper, a patch antenna with a simple rectangular DGS is studied, as shown in Fig. 2. The substrate is 2mm thick RT5880 whose relative permittivity is 2.2. The distance between the coaxial probe and center of the antenna is 6.5mm along y -axis. The width of each rectangular slot on the patch is 2mm. The parameters to be optimized are the size (g_x , g_y and t) of the DGS on the ground and the slot location S_i ($i=1, 2$) and length l_i ($i=1, 2$) on the patch. A rectangular patch antenna without slots is used as a reference antenna, with a patch of $38.4 \times 24.4 \text{ mm}^2$ and a ground of $75 \times 65 \text{ mm}^2$.

Before the whole optimization process, sweeping each optimized parameter while

maintaining the other parameter constant in HFSS is needed to determine a_i and T_i in (1). As mentioned above, the tabu list is obtained with the radiation requirement, and the antenna operating frequency of 3.7GHz is considered in this example. The impact of different parameters on the operating frequency is shown in Fig. 3. So, a_i is appropriately determined by the slope of each curve, and T_i is appropriately the value corresponding to 3.7GHz for each curve, respectively. It is obvious that the slopes of g_x and g_y are the same and larger than those of l_1 and l_2 . Therefore, a_i corresponding to g_x, g_y, l_1 and l_2 are set to 3, 3, 2 and 2, respectively. T_i can be determined as 17.5, 12.5, 12.5 and 12.5 by the intersection points of the dotted line ($f=3.7\text{GHz}$) and curves, respectively. An appropriate tabu list is shown in Table 1 through the pre-determination from HFSS.

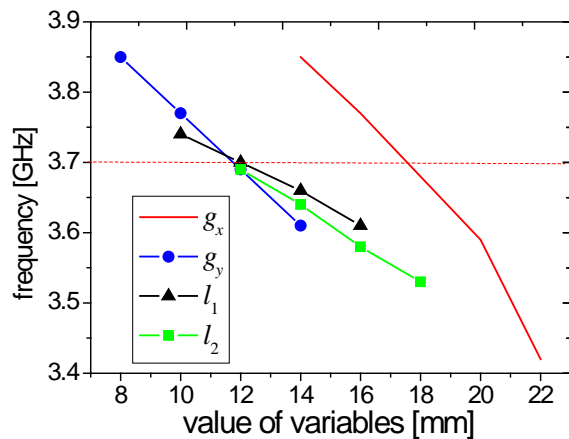

Fig. 3. Effect of the key parameters.

Table 1. Information of the tabu list

	g_x	g_y	l_1	l_2
a	3	3	2	2
$T(\text{mm})$	17.5	12.5	12.5	12.5

A population incorporates 40 individuals and the maximal iteration of generation is 10. The acceptable radiation performance in Fig. 1 is set as $S_{11} < -15\text{dB}$ and gain > 7 dB, respectively. Besides, the best 10% individuals of population have been considered as the elitists. In this numerical example, the reference score is set to 83. Due to the reference score, about 20% individuals in the population for each generation have been considered as the bad ones and they are

unnecessary to be simulated in HFSS. Thus, the tabu list reduces the amount of 20% calls of the time-consuming EM solver to improve the optimization efficiency. Figure 4 shows the convergence for RCS reduction of the GA program, which consists of the average and minimum values of average RCS of different incident angles for each generation. The optimization results are listed in Table 2.

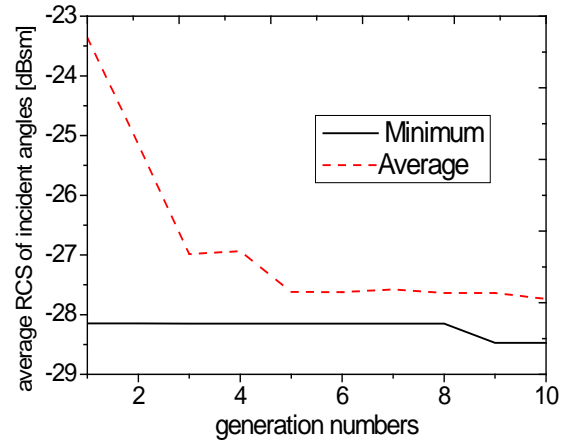

Fig. 4. Convergence for RCS reduction of the GA.

Table 2. Geometry of the optimized antenna (unit: mm)

Patch	Location(x, y)		l
	S_1	S_2	
Ground	g_x	g_y	t
	15	8	2

Figure 5 depicts the return loss of the optimized antenna and reference antenna. Both their resonant frequencies are 3.7GHz. Compared with the reference antenna, the impedance bandwidth ($S_{11} < -10$) of the optimized antenna doesn't decrease. Both the xoz -plane and the $yo z$ -plane radiation patterns of the antennas at the resonant frequency are shown in Fig. 6. It can be observed that the gains of the optimized antenna decreases from 8.4 to 7.3dB when $\theta = 0^\circ$. The reduction of 1.1dB is mainly because the DGS loses some radiation energy in the backward direction.

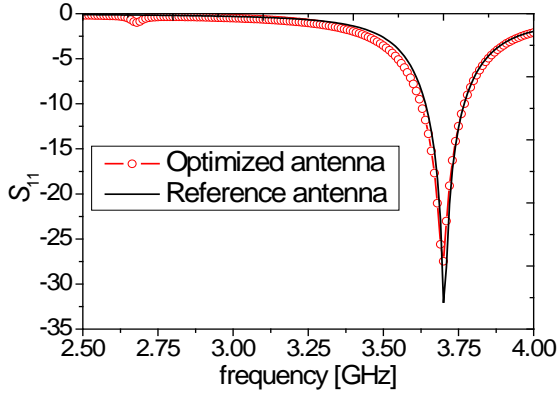
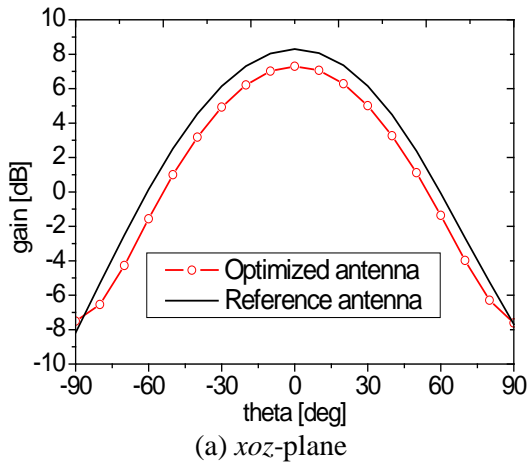
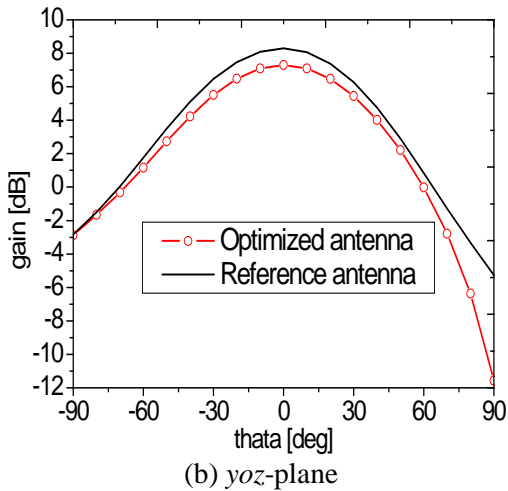

Fig. 5. S_{11} of the reference and optimized antennas.



(a) xoz -plane



(b) yo z -plane

Fig. 6. Simulated radiation patterns of the reference and optimized antennas at 3.7 GHz.

The comparisons of RCS versus frequency between the optimized antenna and reference antenna for different incident angles are shown in Fig. 7. The incident plane wave is with the θ polarization. As shown in Fig. 7, the monostatic

RCS of the optimized antenna is reduced in the frequency range of 2-8 GHz.

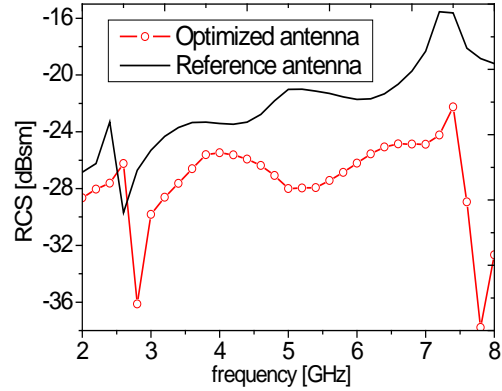

(a) Incident angle ($\theta = 60^\circ, \varphi = 0^\circ$)

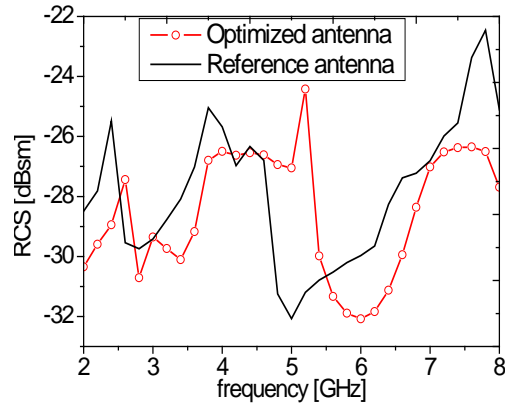

(b) Incident angle ($\theta = 60^\circ, \varphi = 45^\circ$)

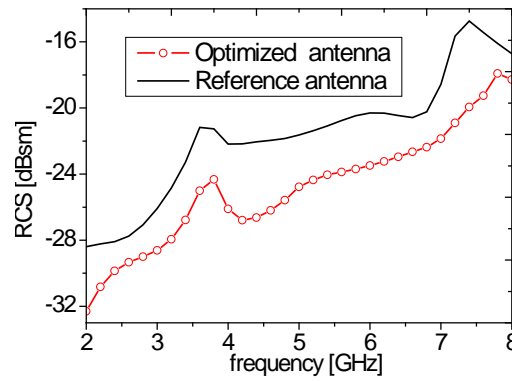

(c) Incident angle ($\theta = 60^\circ, \varphi = 90^\circ$)

Fig. 7. Simulated RCS of the reference and optimized antennas.

In [5], the proposed antenna with DGS does not obtain the marked RCS reduction compared to a reference patch antenna. The proposed DGS antenna in this paper gets a remarkable RCS

reduction compared to its reference patch antenna from Fig. 7.

IV. CONCLUSION

This paper proposes a simple and efficient approach that combines the GA/tabu list optimizer with HFSS to design low RCS patch antennas. The tabu list eliminates some bad individuals of the population and reduces time consuming. In addition, the proportionate selection together with the elitist model for the selection strategy and the two-point crossover accelerate the convergence of the GA. The data exchange between the optimization module and simulation module is realized automatically by VBScript language. The results show that the convergence of the program is fast and the optimized antenna achieves the obvious RCS reduction in a broad frequency range from 2 to 8 GHz at different incident angles, while it maintains good radiation performances.

ACKNOWLEDGMENT

This work was supported in part by the NCET Foundation (11-0065), the Natural Science Foundation of China (60901023), and the Fundamental Research Funds for the Central Universities (ZYGX2010J043).

REFERENCES

- [1] E. F. Knot, J. F. Sbaeffer and M. T. Tuley, *Radar Cross Section*, 2nd ed. Artech House, London, 1993.
- [2] W. Jiang, Y. Liu, S. X. Gong, and T. Hong, "Application of Bionics in Antenna Radar Cross Section Reduction," *IEEE Antennas Wireless Propag. Lett.*, vol. 8, pp. 1275-1278, 2009.
- [3] R. Kumar and P. Malathi, "Design of CPW-Fed Ultra Wideband Fractal Antenna and Backscattering Reduction," *Journal of Microw., Optoelectronics Electromag. Applications*, vol. 9, no. 1, pp. 10-19, 2010.
- [4] L.-S. Ren, Y.-C. Jiao, J.-J. Zhao, and F. Li, "RCS Reduction for a FSS-Backed Reflectarray using a Ring Element," *Progress In Electromagnetics Research*, vol. 26, pp. 115-123, 2011.
- [5] S.-C. Zhao, B.-Z. Wang and Q.-Q. He, "Broadband Cross Section Reduction of a Rectangular Patch Antenna," *Progress In Electromagnetics Research*, vol. 79, pp. 263-275, 2008.
- [6] Y. R.-Samii and E. Michielssen. *Electromagnetic Optimization by Genetic Algorithms*, John Wiley & Sons, New York, 1999.
- [7] R. L. Haupt, "An Introduction to Genetic Algorithms for Electromagnetics," *IEEE Antennas and Propagation Magazine*, vol. 37, no. 2, pp. 7-13, 1995.
- [8] H. Mosallaei and Y. R. Samii, "RCS Reduction of Canonical Targets using Genetic Algorithm Synthesized RAM," *IEEE Trans. Antennas Propag.*, vol. AP-48, no. 10, pp. 1594-1606, 2000.
- [9] H.-T. Chen, G.-Q. Zhu, and S.-Y. He, "Using Genetic Algorithm to Reduce the Radar Cross Section of Three-Dimensional Anisotropic Impedance Object," *Progress In Electromagnetics Research B*, vol. 9, pp. 231-248, 2008.
- [10] W. Wang, S. Gong, X. Wang, Y. Guan and W. Jiang, "Differential Evolution Algorithm and Method of Moments for the Design of Low-RCS Antenna," *IEEE Antennas Wireless Propag. Lett.*, vol. 9, pp. 295-298, 2010.
- [11] X. Zhu, W. Shao, J.-L. Li, and Y. Dong, "Design and Optimization Low RCS Patch Antenna Based on GA," *Progress In Electromagnetics Research*, vol. 122, pp. 327-339, 2012.
- [12] Y. Zhou, J. Li, and H. Ling, "Shape Inversion of Metallic Cavities using Hybrid Genetic Algorithm Combined with Tabu List," *Electronics Letters*, vol. 39, no. 3, pp. 280-281, 2003.
- [13] Y. J. Sung, M. Kim, and Y. S. Kim, "Harmonics Reduction with Defected Ground Structure for a Microstrip Patch Antenna," *IEEE Antennas Wireless Propag. Lett.*, vol. 2, pp. 111-113, 2003.
- [14] D. Guha, C. Kumar, and S. Pal, "Improved Cross-Polarization Characteristics of Circular Microstrip Antenna Employing Arc-Shaped Defected Ground Structure (DGS)," *IEEE Antennas Wireless Propag. Lett.*, vol. 8, pp. 1367-1369, 2009.
- [15] K. H. Chiang and K. W. Tam, "Microstrip Monopole Antenna with Enhanced Bandwidth using Defected Ground Structure," *IEEE Antennas Wireless Propag. Lett.*, vol. 7, pp. 532-535, 2008.
- [16] D. B. Hou and S. Xiao, "Elimination of Scan Blindness with Compact Defected Ground Structures in Microstrip Phased Array," *IET Microw. Antennas Propag.*, vol. 3, pp. 269-275, 2009.
- [17] S. Xiao and M. C. Tang, "Mutual Coupling Suppression in Microstrip Array using Defected Ground Structure," *IET Microw. Antennas Propag.*, vol. 5, pp. 1488-1494, 2011.

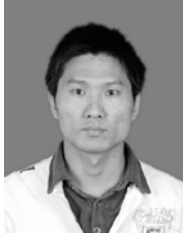

Xinyue Zhu received the B. E. degree in Henan Polytechnic University, Jiaozuo, China, in 2009. From 2009 to now, he is pursuing the M. Sc. degree in the Institute of Applied Physics at the University of Electronic Science and Technology of China (UESTC), Chengdu, China. His current research interests include the antenna design and optimization method.

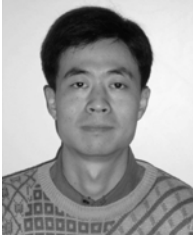

Wei Shao received the M. Sc. and Ph. D. degrees in Radio Physics from UESTC, Chengdu, China, in 2004 and 2006, respectively. He joined the UESTC and is now an associate professor. He has been a Visiting Scholar in the Electromagnetic Communication Laboratory, Pennsylvania State University in 2010. His research interests include the computational electromagnetics and antenna technique.



Jia-Lin Li received the M. Sc. degree from UESTC, Chengdu, China, in 2004, and the Ph. D. degree from the City University of Hong Kong, Hong Kong, in 2009, both in Electronic Engineering. Since Sept. 2009, he has been with the Institute of Applied Physics, School of Physical Electronics, UESTC, where he is currently a Professor. His research interests include the high performance antennas, circuits and systems.