

A Novel Circular Disc Monopole Antenna for Dual-Band WLAN Applications

Bing Li, Jing-song Hong, and Bing-Zhong Wang

Institute of Applied Physics
University of Electronic Science and Technology of China, Chengdu, 610054, China
libing0920@gmail.com

Abstract — This paper presents a novel and simple circular disc monopole antenna with a tunable H-shaped ground plane which provides two separate resonant modes to achieve 2.4- and 5.5-GHz dual-band operation for wireless local area network (WLAN) applications. The proposed antenna is printed on a low cost substrate FR4 ($\epsilon_r=4.4$) and excited using a $50\ \Omega$ microstrip transmission line. Lower resonant mode of the antenna has an impedance bandwidth ($|S_{11}| < -10$ dB) of 700 MHz (2250-2950 MHz), and the upper resonant mode has a bandwidth of 1100 MHz (4900-6000 MHz). For validation purposes, an antenna prototype was fabricated and tested. The measured and simulated results show relatively good agreement and confirm satisfactory radiation characteristics. Effects of varying the widths of the arms of the H-shaped ground plane on antenna performance have also been studied.

Index Terms — Dual-band, H-shaped ground plane, monopole antenna, WLAN.

I. INTRODUCTION

During the recent years, there are rapid developments in wireless local area network (WLAN) applications. In order to satisfy the 2.45 GHz (2400-2483 MHz) band of IEEE 802.11b/g, 5.2 GHz (5150-5350 MHz), and 5.8 GHz (5725-5825 MHz) band of 802.11a WLAN standard, antennas with enhanced dual- or multi-frequency capabilities to meet the IEEE 802.11 WLAN standards in the 2.45/5.2/5.8 GHz operating bands, are in demand for practical WLAN applications. Printed monopole antennas are good candidates owing to their attractive features, e.g. simple

structures, low cost, low profile, light weight, omni-direction radiation patterns, easy realization, and convenience for integrating with microwave monolithic integrated circuit (MMIC) technologies.

Various kinds of printed monopole antennas, such as a microstrip fed printed double-T monopole antenna [1] and antennas with double L-slits [2], G-shaped radiating strip [3], semicircular and rectangular patch with H-shaped ground [4], and other antennas [5-9] have been reported to achieve dual band characteristics, which cover the 2.4- and 5.2- GHz WLAN bands. For the available designs, the antennas reported in [1, 4] can not achieve a dual-band response with sufficiently large bandwidth to cover the 2.45/5.5 GHz (2400–2483/ 5150–5825 MHz) bands. The antenna reported in [2] does not satisfy low-profile configurations. Other antennas mentioned in [3-9] are either large in antenna size or complex in antenna structure. Furthermore, the antennas in [10-12] require a shorting pin for the ground connection inside the printed monopole antenna element. This increases the design complexity as well as the fabrication cost. The antennas mentioned in [13, 14] provide a method to obtain broad bandwidth with a printed circular disc patch, but they are not suitable for WLAN applications. It noted that the longer strip controls the lower band of the antenna, while the shorter strip and the parasitic strip together generate the wide operating band for the upper resonance, so a popular method to obtain broad bandwidth is to use parasitic patches and short the parasitic or the monopole patches. As known, the antenna resonant frequencies depend on more parameters like slot

width, length etc, and thus the complexities of simulation, optimization, and fabrication for antenna increase by adding the parasitic patches.

Based on the background of the researches above, this paper proposes a novel microstrip-fed dual-band monopole antenna with simple structure, small size, and tuneable central frequency ratios. The proposed antenna is comprised of a circular disc patch and an H-shaped ground, it can be easily excited by a $50\ \Omega$ microstrip line. By tuning the widths of the arms of the ground plane, the central frequency ratios of the two operating frequencies can be adjusted. This means that the H-shaped ground plane can be a universal structure to design the dual-band printed monopole antenna which can satisfy different demands. Good impedance matching can be obtained for operating frequencies in the 2.45/5.2/5.8 GHz bands. The three-dimensional (3-D) EM simulator HFSS (based on the finite element method) is used. In this paper, $50\ \Omega$ wave port, ideal radiation boundary, solution frequency of 2.45 and 5.5 GHz is adopted) is used for design simulation. Design details of the proposed antenna are described, and results of impedance bandwidth, the radiation characteristics and gains are given and discussed in this paper.

This paper is organized as follows. The proposed antenna structure is briefly described in Section II. The measured and simulated results are discussed in Section III. Finally, the implications and significance of this work are briefly discussed in Section IV.

II. THE PROPOSED ANTENNA STRUCTURE AND DESIGN

Shown in Fig. 1 (a) is the schematic of the proposed antenna. The antenna with a radius of R and a $50\ \Omega$ microstrip feed line are printed on the same side of the dielectric substrate (in this paper, the FR4 substrate of thickness 1.6 mm and relative permittivity 4.4 was used as a lossless dielectric model). L and W denote the length and the width of the dielectric substrate, respectively. The width of the microstrip feed line is fixed at $W_1 = 3\ \text{mm}$ to achieve $50\ \Omega$ impedance. d is the distance of the feed gap between the feed point and the ground plane. On the other side of the substrate, the conducting H-shaped ground plane only covers the section of the microstrip feed line. Shown in Fig. 1

(b) is the return loss of antennas with different patches, the same H-shaped ground plane and the same dielectric substrate. The bandwidth of antenna with circular disc patch is larger and better than that with rectangular patch. The antenna still produces dual-band with the different patches. As a result, a common method to obtain broad bandwidth is to use circular disc patch, and the major effect of the H-shaped ground plane is to make current paths of the two resonant frequencies different, and thus dual resonant modes are excited.

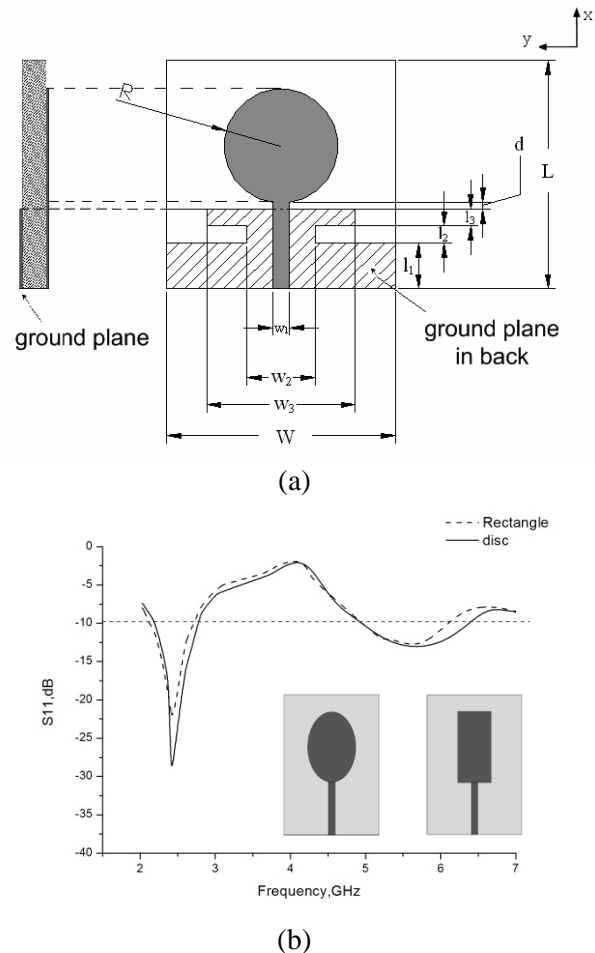

Fig. 1. (a) The configuration of the proposed monopole antenna. (b) The return loss of antennas with rectangular patch and circular disc patch.

In order to obtain the optimal size, the main parameters affecting the antenna bandwidth can be discussed in Fig. 2. The simulated results of three different lengths of $d=0.8, 1.1$ and $1.4\ \text{mm}$, $L_2=2, 3$ and $4\ \text{mm}$, $R_1=8, 10$ and $12\ \text{mm}$ are presented in Fig. 2 (a), Fig. 2 (b), Fig. 2 (c), respectively, and

other dimensions of antenna are not changed. For the three cases in Fig. 2 (a), the upper band is narrow and not good enough when a larger or smaller d is selected, and the lower band is narrow when the smaller d is chosen. In Fig. 2 (b) and Fig. 2 (c) show that as the length of L_2 and R_1 increase, the upper band becomes larger and the lower band becomes smaller. As a result, the best size of antenna is presented in Table 1.

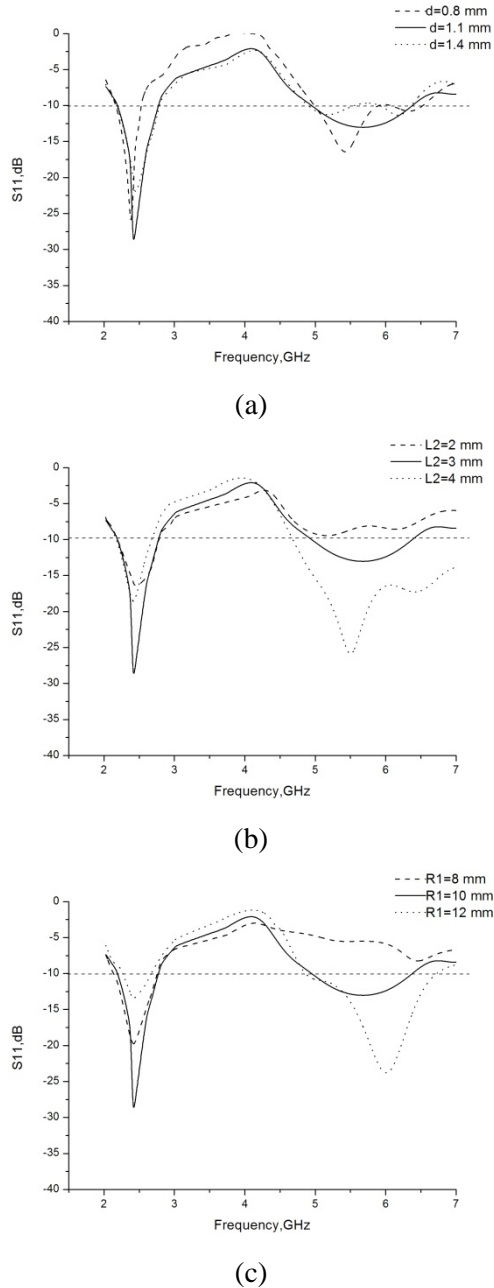

Fig. 2. Simulated reflection coefficient for antennas with various (a) d , (b) L_2 , (c) R_1 .

Table 1: Nominal design parameters of the proposed antenna

Design parameters	Value (mm)
R	10
L	40
l_1	8
l_2	3
l_3	3
d	1.1
W	40
W_1	3
W_2	12
W_3	26

II. RESULTS AND ANALYSIS

A. Radiation characteristic

To investigate the electromagnetic characteristics of the proposed antenna, the excited surface current distributions of the H-shaped ground at the two central resonant frequency 2.45 and 5.5 GHz are simulated, and the sketch is drawn in Fig. 3. It is shown that when the antenna is excited with the same phases and magnitudes, the excited surface current of the lower resonant mode of the antenna is strong in the larger arm of the H-shaped ground plane and weak in the upper arm of the H-shaped ground plane. On the contrary, the excited surface current of the higher resonant mode of the antenna is strong in the upper arm of the H-shaped ground plane and weak in the larger arm of the H-shaped ground plane, and thus the width (W_3) of the upper arm of the H-shaped ground plane controls the second or upper operating band, the width (W) of the larger arm of the H-shaped ground plane controls the first or lower operating band. WLAN bands can be achieved by adjusting the widths of the arms of the H-shaped ground.

To further validate the basic principle of the proposed antenna, a practical example illustrated in Fig. 4 is presented and examined using both simulations and prototype measurements. The dimensions of the antenna are given in Table 1.

The simulated and measured reflection coefficient (dB) of the dual-band antenna is shown in Fig. 5. It is clearly seen that two wide operating bandwidths are obtained, low-frequency bandwidth of the measurement is larger than that of the simulation and high-frequency bandwidth of

the measurement is equal to that of the simulation. The measured lower band achieves a -10 dB impedance bandwidth of 26.9%, ranging from 2.25 GHz to 2.95 GHz, with respecting to the central frequency at 2.6 GHz, and the measured bandwidth for the upper mode reaches 1.1 GHz (4.9–6.0 GHz), or about 20.2%, referred to the central frequency at 5.45 GHz. Obviously, the antenna can operate over the bands which cover the required bandwidths of the IEEE 802.11 WLAN standards in the band at 2.45 GHz (2400–2484 MHz), 5.2 GHz (5150–5350 MHz), and 5.8 GHz (5725–5825 MHz). Although there are some discrepancies between the simulated and measured results, which is probably due to the accuracy issues in making the prototype antenna as well as simulation or measurement errors and the stability of dielectric material, the agreement between the measured data and the simulated results is fairly good.

The simulated radiation patterns of the antenna at the central frequencies of the two WLAN bands are shown in Fig. 6 and Fig. 7, it is seen that the obtained radiation patterns are not as good as those of a conventional ideal monopole antenna, which has a good omni-directional pattern, they are more directional. For the E-plane (xz-plane), the radiation patterns of the proposed antenna are similar at 2.45/5.25/5.75 GHz. For the H-plane (yz-plane), the radiation pattern at 2.45 GHz can also be seen to be more directional than those at 5.25/5.75 GHz, the radiation pattern at 5.25/5.75 GHz has a good omni-direction.

Table 2 shows the antenna gains at lower operating band. In the 2.4 GHz band, the peak gain is 4.8 dBi at 2.8 GHz, 3.5 dBi at 2.4 GHz, and 1.4 dB of gain variation observed. Table 3 shows the antenna gain at upper operating band. In the 5.5 GHz band, the peak gain reaches 4.1 dBi at 6 GHz, 2.9 dBi at 5.2 GHz, and 4.0 dBi at 5.8 GHz, gain variation is less than 1.5 dB. Gain tends to be a constant in the whole band.

Table 2: Realized gain of lower operating band

Frequency (GHz)	2.2	2.4	2.6	2.8	3.0
Gain (dBi)	3.4	3.5	4.3	4.8	4.6

Table 3: Realized gain of upper operating band

Frequency (GHz)	4.9	5.2	5.5	5.8	6.0
Gain (dBi)	3.1	2.9	2.8	4.0	4.1

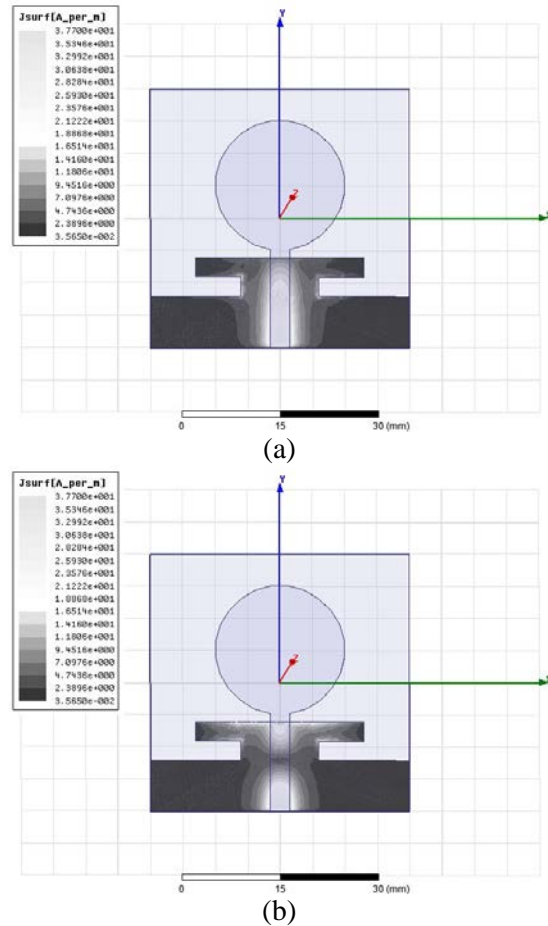

Fig. 3. Simulated surface current distributions of the H-shaped ground plane: (a) at 2.45 GHz, (b) at 5.5 GHz.

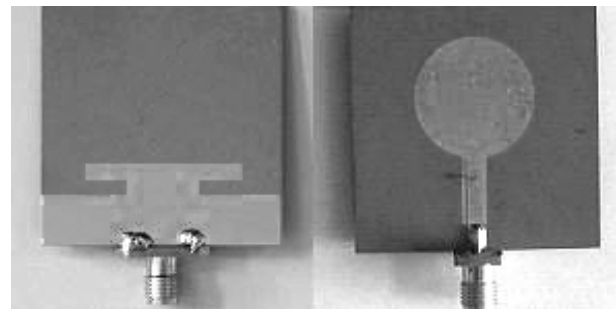

Fig. 4. The photo and configuration of the proposed monopole antenna.

Shown in Fig. 8 is the radiation efficiency for antenna, it can be seen that the radiation efficiency reaches more than 70% at lower operating band, and it is above 75% at upper operating band. In the non-operating band, the radiation efficiency for antenna is below 60%. In the whole band, the antenna obtains a good radiation characteristic.

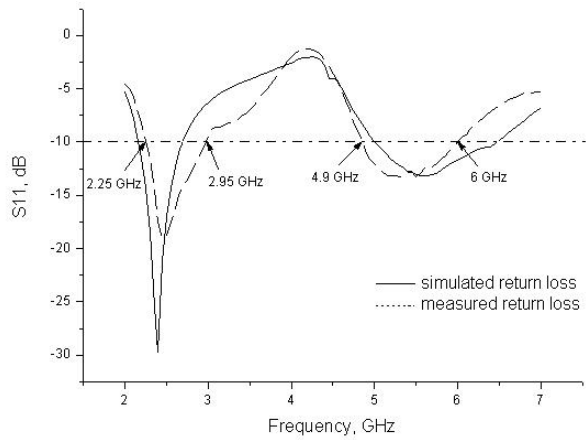

Fig. 5. Reflection coefficient of the antenna.

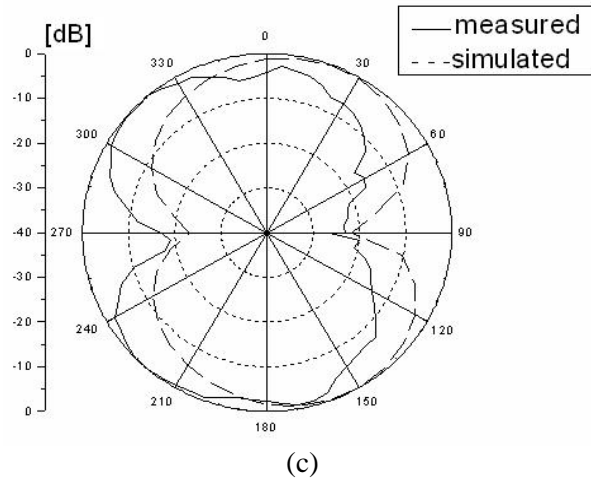
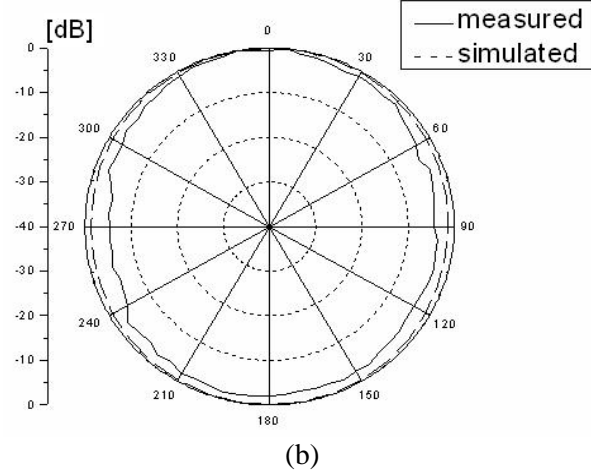
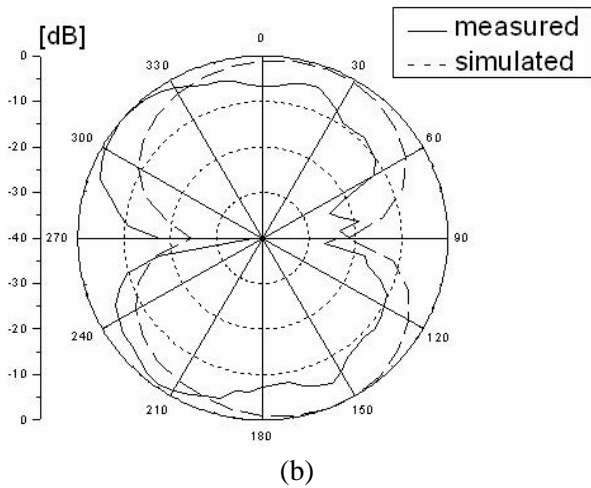
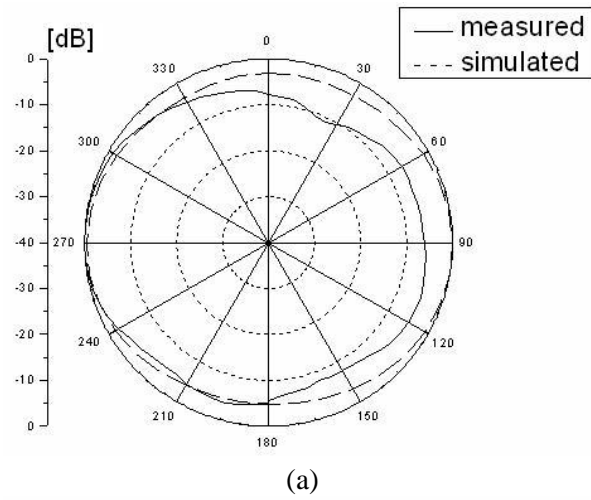
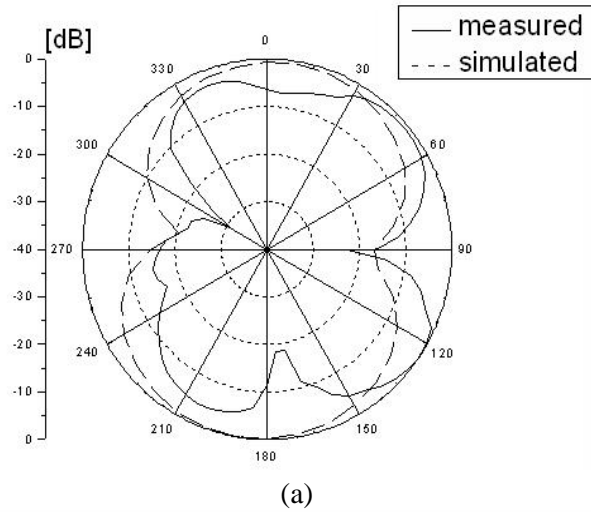

Fig. 6. E-plane radiation patterns of the proposed antenna. (a) 2.45 GHz, (b) 5.25 GHz, (c) 5.75 GHz.



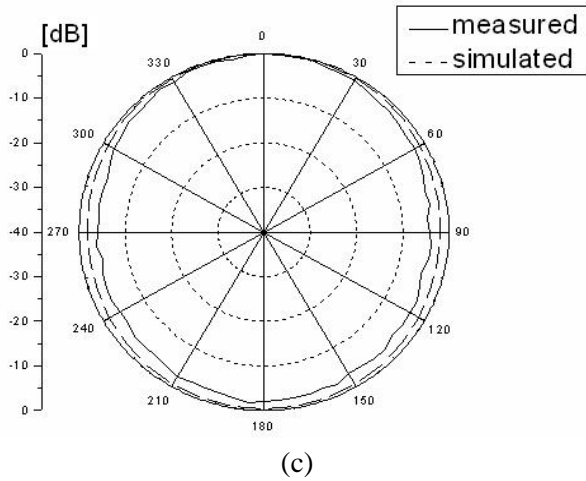

Fig. 7. H-plane radiation patterns of the proposed antenna. (a) 2.45 GHz, (b) 5.25 GHz, (c) 5.75 GHz.

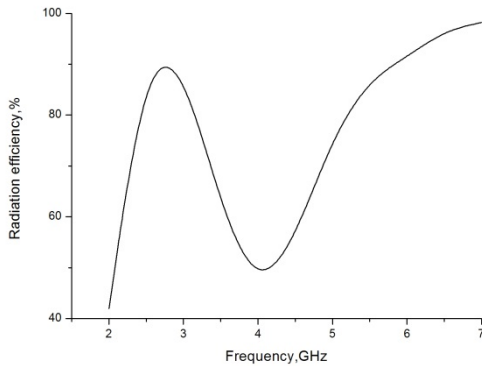

Fig. 8. Simulated radiation efficiency for antenna.

B. Effects of varying the widths of the arms of the ground plane

The parameters effect on the antenna’s resonant frequency and impedance bandwidth are studied.

Figure 9 shows that the central frequency of the higher resonant mode decreases with the increase of the width of the upper arm of the ground plane, while that of the lower resonant mode is nearly unchanged, and both of the impedance bandwidths are almost unchanged. Figure 10 shows that the central frequency of the lower resonant mode decreases with the increase of the width of the larger arm of the ground plane, while that of the higher resonant mode is nearly unchanged, and both of the impedance bandwidths are almost unchanged. This means that by varying the widths of the arms of the H-shaped ground plane, the central frequency ratio of the proposed

antenna can be adjusted. Making a compromise between size and bandwidths of the antenna, the final parameters are shown in Table 1.

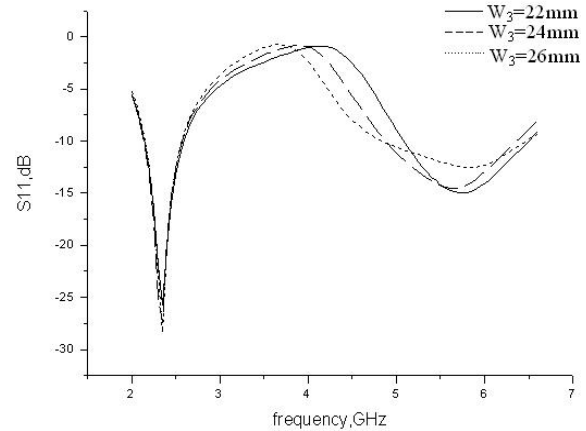

Fig. 9. Simulated reflection coefficient for antennas with various W_3 .

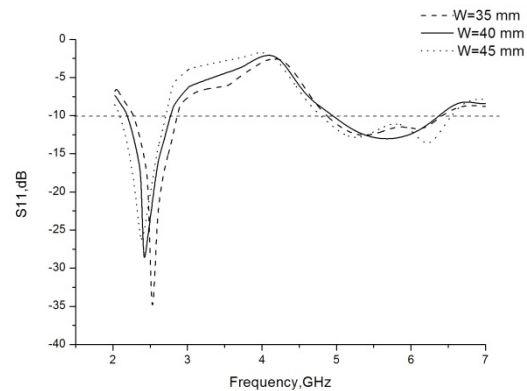

Fig. 10. Simulated reflection coefficient for antennas with various W .

As a result, one of the advantages of the proposed antenna is that it can meet the different bands for communication equipments by changing the widths of the arms of the H-shaped ground plane without changing other parameters.

IV. CONCLUSION

A novel dual-band monopole antenna excited by microstrip has been demonstrated in this paper. The proposed antenna has a simple structure. Moreover, by adjusting the widths of the arms of the H-shaped ground plane, the central frequency ratio of the antenna can be tuned so that the H-shaped ground plane can be used for designing the dual-band printed monopole antennas in order to satisfy different communication needs. After

optimizing the geometric parameters of the antenna, the proposed antenna can provide two discrete operating bands, which cover both 2.45 GHz (2.4-2.484 GHz) and 5 GHz (5.15-5.825 GHz) bands. The final measured results show satisfactory performance. Because the measured and simulated results are found to be in good agreement, the proposed antenna has been successfully designed for use in dual-band WLAN applications.

ACKNOWLEDGMENT

This work was supported by the National Natural Science Foundation of China (No. 60872029 and No. 60872034), the High-Tech Research and Development Program of China (No. 2008AA01Z206), the Aeronautics Foundation of China (No.20100180003), and the Fundamental Research Funds for the Central Universities (No. ZYGX 2009J037).

REFERENCES

- [1] Y. L. Kuo and K. L. Wong, "Printed Double-T Monopole Antenna for 2.4/5.2 GHz Dual-Band WLAN Operations," *Antennas and Propagation, IEEE Transactions on*, 51(9), pp. 2187-2192, 2003.
- [2] T. H. Kim and D. C. Park, "Compact Dual-Band Antenna with Double L-Slits for WLAN Operations," *Antennas and Wireless Propagation Letters, IEEE*, 4, pp. 249-252, 2005.
- [3] C. Y. Pan, C. H. Huang, and T. S. Horng, "A New Printed G - Shaped Monopole Antenna for Dual - Band WLAN Applications," *Microwave and Optical Technology Letters*, 45(4), pp. 295-297, 2005.
- [4] G. M. Zhang, et al., "A Novel Planar Monopole Antenna with an H-Shaped Ground Plane for Dual-Band WLAN Applications," *Journal of Electromagnetic Waves and Applications*, 21(15), pp. 2229-2239, 2007.
- [5] H. Wang and M. Zheng, "An Internal Triple Band WLAN Antenna," *Antennas and Wireless Propagation Letters, IEEE*, 48(5), pp. 829-835, 1999.
- [6] H. Liu, S. Lin, and C. Yang, "Compact Inverted-F Antenna with Meander Shorting Strip for Laptop Computer WLAN Applications," *Antennas and Wireless Propagation Letters, IEEE*, 10, pp. 540-543, 2011.
- [7] S. H. Yeh and K. L. Wong, "Dual-Band F-Shaped Monopole Antenna for 2.4/5.2 GHz WLAN Application," *IEEE Antennas and Propagation Society International Symposium*, 2002.
- [8] C. H. See, et al., "Dual-Frequency Planar Inverted FL-Antenna (PIFLA) for WLAN and Short Range Communication Systems," *Antennas and Propagation, IEEE Transactions on*, 56(10), pp. 3318-3320, 2008.
- [9] H. D. Chen, J. S. Chen, and Y. T. Cheng, "Modified Inverted-L Monopole Antenna for 2.4/5 Ghz Dual-Band Operations," *Electronics Letters*, 39(22), pp. 1567-1568, 2003.
- [10] Y. L. Kuo, T. W. Chiou, and K. L. Wong, "A Novel Dual - Band Printed Inverted - F Antenna," *Microwave and Optical Technology Letters*, 31(5), pp. 353-355, 2001.
- [11] J. Y. Jan and L. C. Tseng, "Planar Monopole Antennas for 2.4/5.2 Ghz Dual-Band Application," *IEEE Antennas and Propagation Society International Symposium*, 2003.
- [12] C. Y. Chiu, P. L. Teng, and K. L. Wong, "Shorted, Folded Planar Monopole Antenna for Dual-Band Mobile Phone," *Electronics Letters*, 39(18), pp. 1301-1302, 2003.
- [13] J. Liang, et al., "Study of a Printed Circular Disc Monopole Antenna for UWB Systems," *Antennas and Propagation, IEEE Transactions on*, 53(11), pp. 3500-3504, 2005.
- [14] S. Dey, N. Saha, and S. Biswas, "Design and Performance Analysis of UWB Circular Disc Monopole Textile Antenna and Bending Consequences," *IEEE*, pp. 1129-1133, 2011.



Bing Li is a graduate student majoring in Radio Physics in the University of Electronic Science and Technology of China now. Her research interests include antenna technology and wireless communication technique.



Jing-song Hong received the B.Sc. degree in Electromagnetics from Lanzhou University, China, in 1991, and the M.Sc. and Ph.D. degrees in Electrical Engineering from the University of Electronic Science and Technology of China (UESTC), in 2000 and 2005, respectively. He is now a professor with UESTC. From 1991 to 1993, he was a Circuit Designer with the Jingjiang Radar Factory, Chengdu, China. From 1993 to 1997, he was a Testing Engineer with SAE Magnetics (HK) Ltd, Guangdong, China. From 1999 to 2002, he was a Research Assistant with the City University of Hong Kong. His research interest includes the use of numerical techniques in electromagnetics and

the use of microwave methods for materials characterization and processing.



Bing-zhong Wang received the B.S.E.E., M.S.E.E., and Ph.D. degrees from the University of Electronic Science and Technology of China (UESTC), Chengdu, in 1982, 1984, and 1988, respectively, all in Electrical Engineering. He joined the

Institute of Applied Physics, UESTC, in 1984. From 1984 to 1988, he was a Research Assistant, and his research dealt with the millimeter-wave transmission lines and millimeter-wave integrated circuits. From 1988 to July 1990, he served as a Lecturer/Research Associate in the Institute of Applied Physics at UESTC, conducting researches in electromagnetic scattering. From August 1990 to January 1992, he was with the Department of Electrical Engineering, University of Wisconsin-Milwaukee, where he was a Visiting Scientist in the Signal Propagation Research Laboratory and engaged in research on the theoretical modeling of the electromagnetic behavior of high-speed integrated circuits. He returned to UESTC in 1992 as an Associate Professor and was promoted as a Full Professor in June 1995. From August 1996 to August 1997, he was a Visiting Research Fellow in the Department of Electronic Engineering at the City University of Hong Kong. From January 2000 to March 2000, he was a Visiting Professor in the Electromagnetic Communication Research Laboratory, Pennsylvania State University, and University Park. His current research interests are in the areas of computational electromagnetics, numerical modeling and simulation of the electromagnetic behavior in high speed integrated circuits and electronic packages, EMC analysis, electromagnetic modeling by artificial neural networks, computer aided design for passive microwave and millimeter wave integrated circuits, and antenna design.