

CEM TECHNIQUES FOR ANALYZING ELECTRONIC BATTLESPACE ENVIRONMENT PLATFORM-ANTENNA COUPLING INTERACTIONS

Andrew L. Drozd[†]
ANDRO Computational Solutions
Beeches Technical Campus
Rome, NY 13440
androl@aol.com

Abstract

This article discusses the application of an integrated, multi-fidelity CEM modeling and simulation approach for analyzing EM interactions for complex electronic battlespace environment (EBE) scenarios. A postulated RF EBE simulation model is generated consisting of multiple antenna-mounted air and ground vehicle platforms. The effects of EM environments produced by external RF systems on other distributed platforms are analyzed. Included in the simulation model are radars, RF communications systems, multi-spectral sensors, and other types of intentional as well as deliberate jamming sources. The approach involves modeling the total environment and isolating selected platforms from within the overall scene to analyze mutual coupling, antenna-platform interactions, scattering, and intersystem electromagnetic interference (EMI). Methods are used to automatically generate detailed CEM models of the selected physical systems and their antenna radiators from CAD or other types of data sources. Future directions in antenna analysis and the application of design software for antenna-platform simulations will be discussed.

INTRODUCTION

An EBE scenario can be defined as a digital model of a complex arrangement of multiple RF systems and platforms. The scenario arrangements or configurations can contain both static elements (tanks under trees) and dynamic components (airborne systems). Regardless, the potential for intersystem EMI and mutual EM environment-to-platform coupling interactions exists. One of the basic concerns of EBE strategists and planners is to assure RF communications, command, control, and computing (C⁴) system operability in EM-rich environments. Also, the potential self or co-site interference effects among local (onboard) RF systems is also of concern. For instance, self interference can drastically change the radiated emissions and susceptibility states of onboard transceivers, which in turn may contribute to the overall intersystem EMI problem or lead to additional vulnerabilities in the presence of external EM fluences. In general, the RF EBE scenario typically involves the deployment of multiple systems and platforms in the battlespace volume. Hostile elements (e.g., nearby deliberate jammers) may also be part of the scenario.

In the process of discussing the EBE modeling and simulation approach, several key technology areas will be highlighted. These include: (a) self/mutual antenna coupling and radiation modeling (antenna design and performance, antenna coupling and isolation, sensor siting and interference/jamming mitigation); (b) CAD pre-processing; (c) automated techniques for generating grid models from CAD data; (d) CEM design environment for creating mesh and asymptotic high-frequency ray tracing models; (e) illustrating how computed data can be presented in different ways depending on the needs of the analyst; (f) fidelity issues in modeling the effects of multi-spectral sources or environments (radar, high energy microwaves); and (g) common modeling frameworks for multi-disciplinary engineering applications.

Background

A basis for the RF battlespace scenario is the Open Systems Interconnection (OSI) Reference Model, which deals with the connection of open systems (i.e., systems that are ready to communicate with other systems in a

[†] ANDRO Computational Solutions, Beeches Technical Campus, Bldg. 3, Suite 4, Route 26N, Turin Road, Rome, NY 13440, Tel. (315) 334-1163 or (877) 334-1188, Fax: 315.334.1397, androl@aol.com or androcs@borg.com.

prescribed manner) and Mobile Ad Hoc Networking, which involves route maintenance, disconnect, and so forth. The OSI architecture has seven layers starting at the base with the *physical layer* and upwards, in order, to include the *data link* and *network layers* followed by the *transport*, *session*, *presentation*, and *application protocols*. The present concern is on the first three layers i.e., the *physical*, *data link*, and *network layers* which comprise the *communications subnet boundary* of the OSI model.

There are three perspectives or views on this architecture concept: (1) operational view, which identifies sensor to shooter warfighter relationships and information needs; (2) systems view, which relates capabilities and characteristics to operational requirements for network-centric and multi-echelon connectivity; and (3) technical view, which prescribes standards and conventions. The near and midterm architectures applicable to this concept, for example, include: intelligence, surveillance and reconnaissance (ISR) including SIGINT, HUMINT, and electronic or synthetic aperture radar (SAR) mapping of hostile RF emitters, sensor to shooter, and aerial common sensors and control nodes. The architecture concepts have transitioned from platform-centric to a Global Information Grid (GIG) network centric to maintain the philosophy that the best sensors plus robust networks equals information dominance. What is the relevance here to CEM? The answer lies in the need to reasonably model the EBE “big picture” and characterize the various EM interactions in a multi-fidelity way focusing on critical network nodes. The modeling and simulation approach to accomplish this is described herein.

In the general OSI-based model, RF communications must be assured or maintained to coordinate the transfer of data/information across the OSI Reference Model topology layers, starting with the physical layer and up to the data link and network layers. Nodes and information pathways in the 3-D communications grid represent the connectivity among critical assets in the RF battlespace. These must be able to operate through the EM-rich environment. One way of determining this is through EMI modeling and simulation starting at the physical layer where the systems and platforms operate.

The efficient management of the intersystem EMI problem for *systems of systems* scenarios can be quite tedious and daunting. The analysis procedure requires the application of several different tools and techniques in order to obtain meaningful solutions. Further, top-down and bottom-up modeling are often required implementing an iterative, building block, or step-wise approach to the problem-solving task. The first step, however, is to develop an effective method of performing interference analysis culls to eliminate non-problems from the interaction sample space and to focus on likely or certain interference problems using a high-fidelity approach. This will be demonstrated qualitatively using the *E³EXPERT** technology.

***E³EXPERT* Technology**

E³EXPERT is a computer tool that is used to predict intrasystem or co-site EMI for co-located onboard systems as well as intersystem or mutual EM coupling between external or offboard RF systems and sensors [1-9]. The tool can also analyze the effects of externally-produced multi-spectral EM environments on systems. The program computes the composite EM environment due to multiple sources by integrating the power spectrum across frequency. Both intentional as well as inadvertent (i.e., hostile jammers, enemy radar, ultra wideband, fratricide) sources can be modeled for in-band and out-of-band frequencies (dc to 50 GHz). Environmental sources can be characterized as fixed-tuned (CW tone), variably-tuned (multiple tones), frequency-agile (hopping), pulsed radar (chirp and other forms), and wideband (stochastic or modulated signals).

E³EXPERT can compute the mutual coupling among distributed aerospace, land, and sea systems deployed within the EBE volume that have source and receiver antennas mounted on their structures. The approach involves conservative *physical layer* modeling of reconfigurable *systems of systems* scenarios. The immediate interest is in simulating the EBE problem to analyze the various electromagnetic environment effects (E^3) and distributed system EM interactions at the *physical layer*. This includes analyzing the effects of multiple radar jamming sources on RF communications grids and information/network systems, which addresses the assured RF communications, information systems and network integrity, and tactical information warfare problem.

* Developed by the Air Force Research Laboratory, Rome Research Site under Contract F30602-98-C-0034.

At this layer, E^3 EXPERT models individual radars, communications assets and information systems as nodes. The nodes are analyzed to compute mutual EM coupling interactions as well as to calculate the susceptibility/vulnerability response of the nodes to incident energies from external sources. Intentional radar and communications signals, and information pathways for conventional and more complex signal sources (e.g., mobile spread spectrum radios), as well as fratricide and unintentional or hostile sources can be modeled. Both linear and nonlinear (intermodulation) coupling modes are considered.

EBE scenarios are imported as digital satellite or aerial imagery resulting from multi-sensor fusion processes combined with system platform CAD descriptions as shown in Figure 1. Selected portions of the scene can be extracted and automatically converted into a generalized CEM model as illustrated in the nodal network grid of Figure 2. In this example, the intersystem coupling between a radar mounted ground vehicle and selected airborne systems is to be simulated and analyzed. The induced surface currents and scattered fields due to onboard radiators and ground vehicle radar illumination can be computed to identify potential hot spots or interference situations.

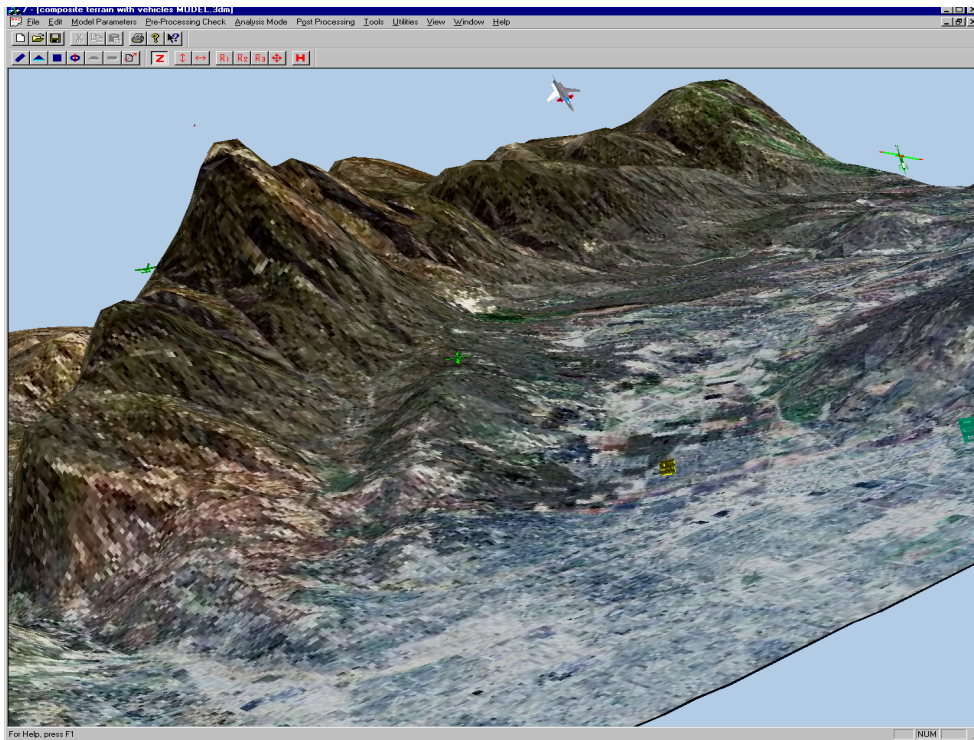

Figure 1. A “Snapshot” of the RF Battlespace Used to Analyze Intersystem EM Interactions

E^3 EXPERT provides the necessary capability to analyze complex systems and scenarios using multi-resolution modeling techniques. This means that models can be analyzed using coarse-fidelity, phase coherent (i.e., conservative) techniques or by applying accurate, high-fidelity CEM techniques, both in the frequency and time domains. One of the codes used to accomplish this is the *General Electromagnetic Model for the Analysis of Complex Systems (GEMACS V6)* [10]. The *GEMACS* code employs high-fidelity physics and numerical solvers to predict mutual coupling, antenna isolation, and scattering. Another computational engine, *SystemView™*, adds a time-domain signal modeling capability to complement the resident frequency-domain techniques [11].

E^3 EXPERT applies a knowledge-based expert system modeling and simulation approach to generate valid computational models and orchestrate the analysis procedures [12] to compute EM scattering and frequency-domain coupling parameters based on an automated system-level methodology. It ranks computed results and automatically specifies an initial set of recommendations to mitigate undesired EM effects in the frequency domain. Detailed mitigation requirements in the time domain can then be deduced.

Computer simulations have been conducted to study the effectiveness of this approach for various complex system scenarios involving externally-mounted fixed- and variably-tuned RF radiating antennas, coherent frequency-hopped and direct sequence spread spectrum radios, and incident radar sources producing both incident CW and wideband pulses. The results of these simulations are qualitatively described below.

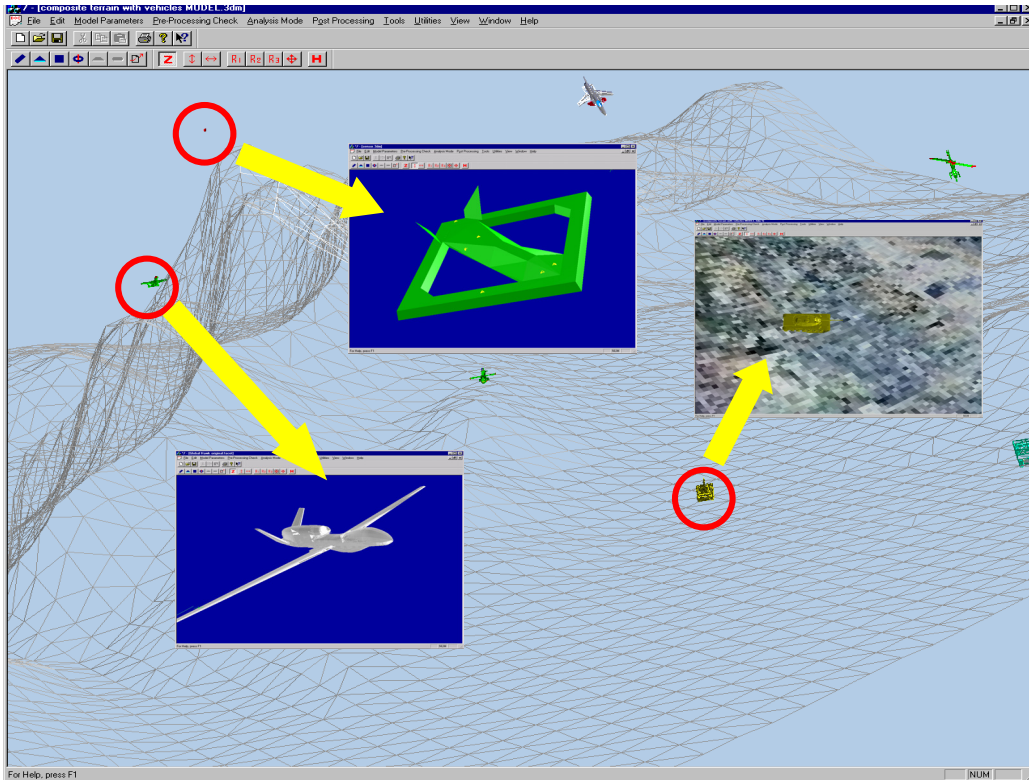

Figure 2. Selecting “Targets” for Intersystem EM Analysis

SCENARIO MODELING

E^3 EXPERT's integrated framework provides a suite of tools to design a scenario consisting of: physical systems, platforms or structures; networks; node models of intentional transmitters and receivers; EM jammers or other interference sources; and EM environments. A physical modeling approach is used to describe an OSI-based EBE scenario where assets are modeled with varying levels of fidelity in accordance with problem-driven constraints and accuracy requirements. E^3 EXPERT provides capabilities to model air-air, air-ground, as well as ground-ground scenarios. In the case of antenna radiators, both terrain and intravehicle coupling models are used to compute propagation path losses.

Frequency and time-domain parameters are used to characterize multi-spectral, multi-sensor system operational states and signal modulations. This defines the operation of high-power radars, mobile wireless spread spectrum radios, and signal/information processing systems. These include systems that utilize low-band technology for dynamically exploiting complex RF environments, high-band technology for dynamically exploiting microwave frequencies and above, RF/microwave transceiver and directional antenna technologies, and a variety of modulation, coding, and information processing schemes.

For the general EBE problem, a *physical layer* model of the OSI network architecture is developed consisting of multi-sensor and multi-function host platforms, RF communications and information processing systems, and EM radiators. The results of the *physical layer* simulation can be interfaced with *network layer* prediction codes in order

to perform end-to-end simulations against specific and reconfigurable combat system scenarios. This approach assists in analytically evaluating the life cycle performance of combat system networks and C⁴ systems that may be exposed to a broad range of EM environments or threats. The results of the analyses can be used to increase the interference and jamming immunity of friendly systems as well as further develop ways of reducing EM signatures to minimize detection and identification, and to exploit the weaknesses of hostile systems.

ANALYSIS PROCEDURE

The EBE computational model is generated from mutually registered and digitized aerial or satellite imagery and terrain elevation data as was shown in Figure 1. CAD model data corresponding to system platforms and targets in the EBE scenario are “linked” to the digitized scene. This was illustrated in Figure 2. The model is then analyzed in the frequency domain to compute EM interactions (scattering, propagation/path loss, coupling, and interference) between all components in the model. Method of moments (MoM) and high-frequency asymptotic uniform theory of diffraction (UTD) ray tracing techniques are used to compute vehicle and ground propagation coupling losses. Computed results for selected CEM structure models and their radiators are ranked according to the type and severity of coupled interference. Corrective measures can then be determined to mitigate or cancel the interference. The *E³EXPERT* knowledge base is designed to assist in determining mitigation solutions. In particular, the knowledge base is used to “monitor” the signal environment in the time domain and select mitigation scheme(s) to excise or suppress undesired EM effects.

The modeling and simulation procedure consists of the following steps:

- 1) Import the digitized battlespace scene and linked CAD models.
- 2) Defeature and discretize the scene to generate a meshed model view to rapidly identify targets and set up the problem to compute intersystem EM propagation/coupling parameters.
- 3) Apply coarse-fidelity, phase coherent simulation techniques to isolate certain or probable intersystem interference cases.
- 4) Based on the results of step 3, select one or more specific platform-antenna structures to analyze the cumulative, incident energy effects and/or to study co-site EM interactions using both coarse- and high-fidelity modeling techniques.
- 5) Using high-fidelity techniques, compute platform propagation path loss, scattering, or isolation for an MoM mesh, UTD surface, or hybrid model based on frequency, desired accuracy, and other “ensemble” parameters.
- 6) Compute and map the predicted surface currents and/or field intensities on the CEM model(s).
- 7) Compute near and far field antenna patterns and antenna input impedances.
- 8) Apply time-domain signal modeling and analysis techniques to study waveform distortion in antenna receiver front ends.
- 9) Evaluate system performance.
- 10) Apply expert system based mitigation solutions, as necessary.

Steps 3 and 4 above are critical transition steps in that they establish the initial EM interaction sample space, which will be further analyzed and reduced using high-fidelity computational techniques at the system level. The effects of cumulative EM environments on selected platforms and onboard receivers can also be computed in these steps. An example of the cumulative EM environment compared to a receiver’s susceptibility of immunity level is shown in Figure 3.

Selecting Model(s) for CEM Analysis

E³EXPERT gives the analyst a capability to rapidly generate valid EM scenario and structure models from selected CAD data, existing CEM model information, and by employing a few basic modeling assumptions. In our example, we have computed all possible EM interactions for all nodes in the model. We are now at the point of analyzing the effect of incident energies from one or more sources in the problem on a given platform and its

receivers. To accomplish this, the analyst can zoom in and select one or more of the targets in the digital battlespace scene and retrieve the corresponding CAD file description(s) of the platform(s) of interest (step 4 in the procedure). This was illustrated for the case of a tank and a postulated unmanned aerial vehicle (UAV) in Figure 2. CAD and rendering formats currently supported by *E³EXPERT* include *IGES*, *DXF*, *facet*, and *VRML* entities.

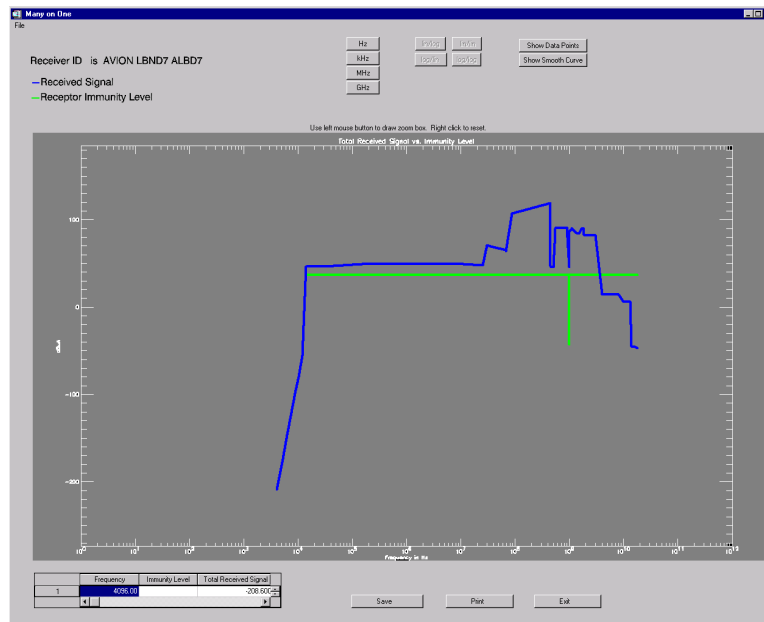

Figure 3. Computation of Cumulative EM Environment to a Victim Receiver

At this point, a CAD or existing CEM model is read in, converted, and stored in an internal 3-D metafile (native) format. The CAD models are converted into CEM models to accommodate one or more of the CEM codes and computational modes supported by *E³EXPERT*. The native file format and internal database structure represent a common modeling environment in which computational models are stored and used in a generic way for various code applications. *E³EXPERT* also performs certain CAD and CEM model preprocessing to identify and “heal” anomalies in the imported model. The role of the metafile and intelligent preprocessor are illustrated in Figures 4 and 5. The present metafile design supports MoM, UTD, and SBR/PO/PTD formalisms related to geometry generation for codes like *GEMACS*, *NEC-MOM*, *NEC-BSC*, *Xpatch* and *Carlos-3D*. It has the potential for supporting other physics formalisms such as finite difference time domain (FDTD), finite element modeling (FEM), multi-level fast multipole algorithm (MLFMA), and volume integral equation (VIE) techniques for selected CEM codes.

Generating CEM Models

For all platform structure models that have been imported or created, the associated multi-sensor and RF communications system antennas are also specified. This includes the specification of the relevant performance measures and EM parameters (excitations, frequencies, operational levels, loads, etc.). Again, the first task is to analyze intersystem coupling interactions and the effects of incident energies on systems in the frequency domain for given structures in the model. This involves the computation of certain EM figures of merit such as mutual coupling or interference margins and isolation. Intrasystem or self interference can also be calculated in terms of local platform scattering effects and mutual coupling between onboard antennas. For instance, antenna performance can be affected by the presence of the platform structure, materials, excitation waveforms, and the operation of other onboard antennas.

Once the structure, performance and EM measures have been defined, multi-fidelity CEM models are generated as a function of frequency and other problem parameters. For example, CAD models can be converted into

equivalent canonical smooth surface structures which are useful in analyzing coupling, scattering, and interference at high frequencies using asymptotic UTD ray tracing methods, in particular, when the structure is electrically large. Alternatively, at lower frequencies where the model is electrically small, the model can be parameterized using a built-in *autogridder* to generate a MoM patch model.

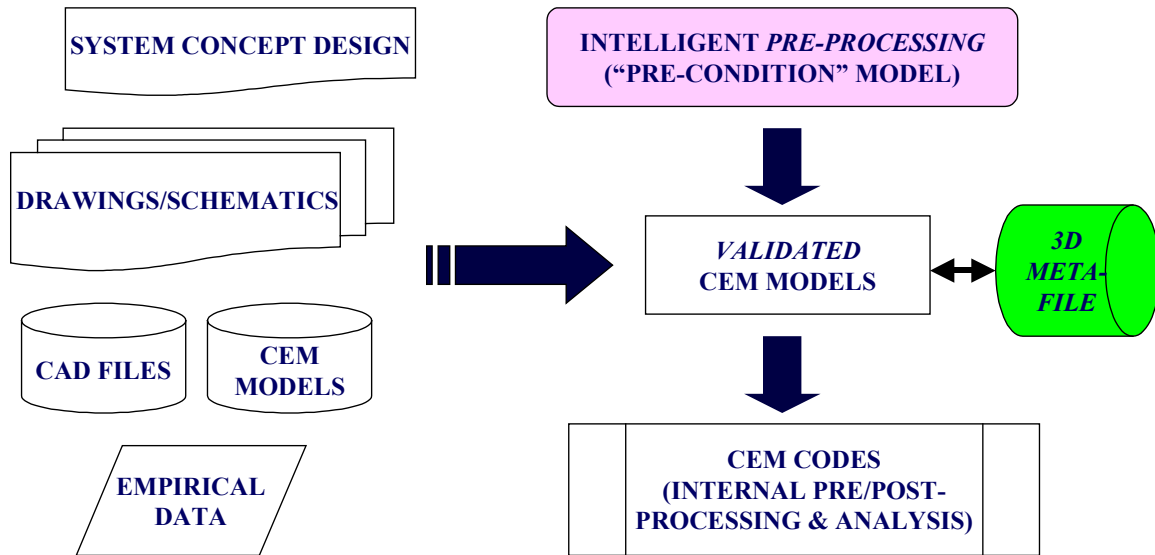

Figure 4. Preprocessing and Database Scheme

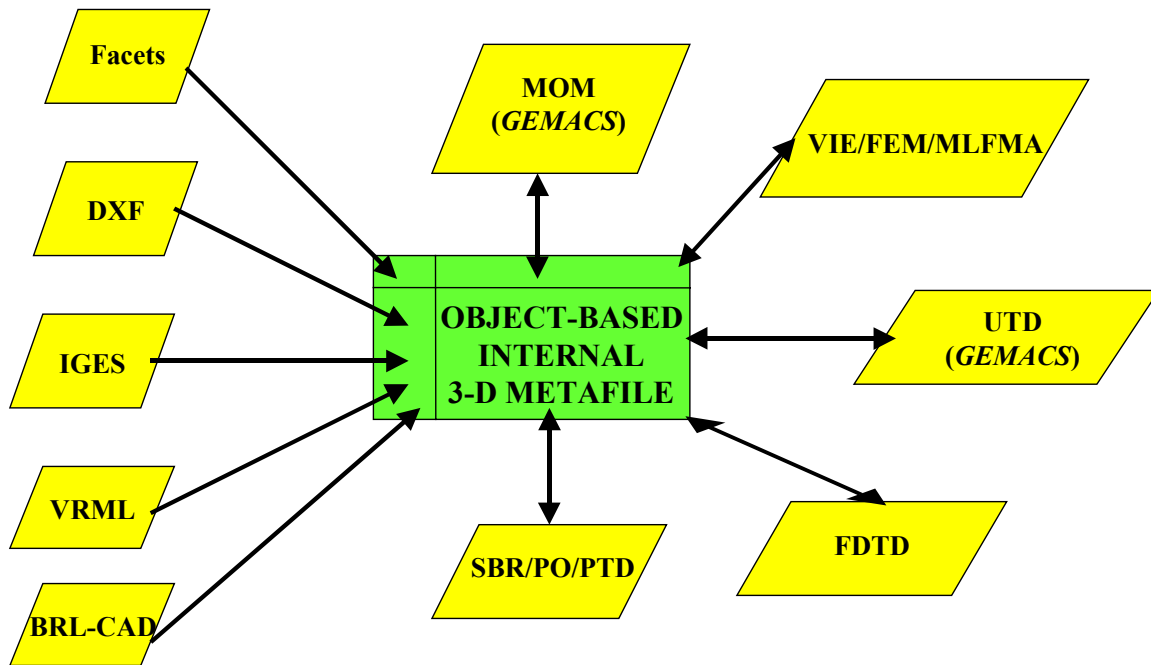

Figure 5. Common Modeling Environment Concept

The general multi-fidelity scheme is illustrated in Figure 6 for the postulated UAV structure. Figures 7 and 8 show models of the UAV generated for high frequencies based on the UTD modeling method. In these figures, coarse and higher fidelity UTD models were generated and comparisons are made of the computed isolation for the

models. As expected, a significant improvement in the isolation is computed at the sample frequency using the more refined models. This illustrates the importance of considering model fidelity in assuring reasonable computational accuracy. Another aspect of the multi-resolution approach based on the autogridding scheme for different mesh resolutions and frequencies is shown in Figures 9.

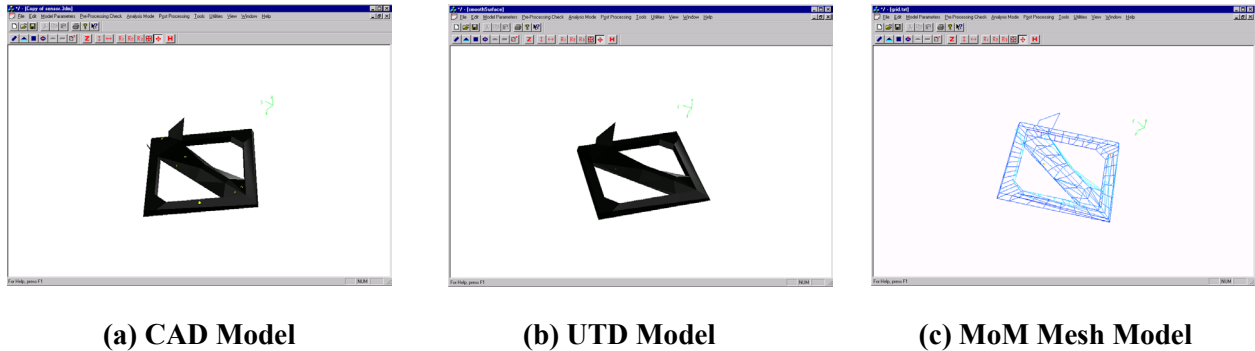

Figure 6. Progression of UAV Models in Multi-Fidelity Scheme

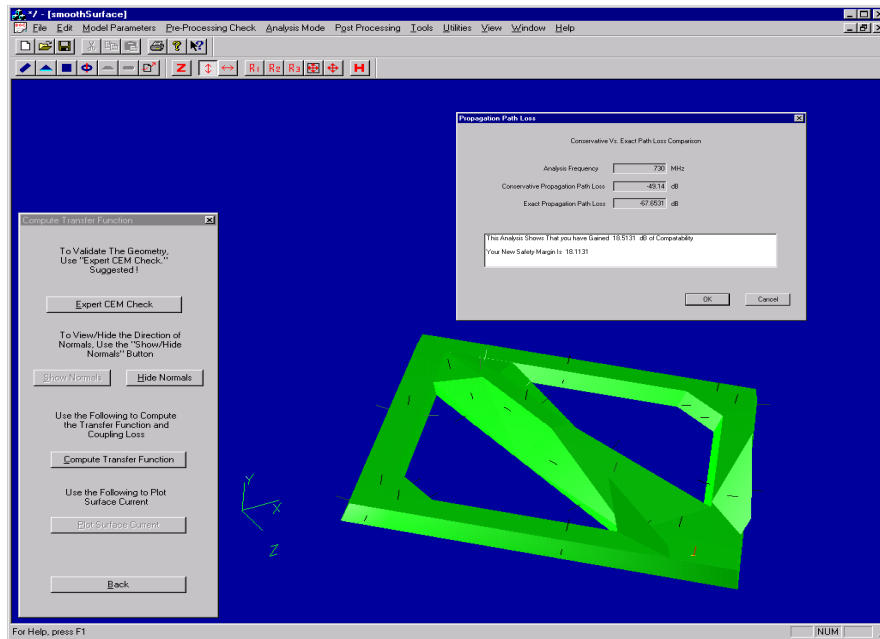

Figure 7. Comparison of Computed Isolation for Coarse and High Fidelity UTD Model at 730 MHz

Figures 10 - 12 show how the autogridding process has been used for other system platforms to produce models of varying fidelity and accuracy for the purpose of analyzing intersystem and intrasystem EM coupling for EBE-type scenarios.

Depending on the desired analysis fidelity, the models may be used “as is” or modified to suite the computational accuracy requirements. For example, E^3 EXPERT is used to convert the detailed facet model into a UTD canonical model and then into a MoM mesh model to compute vehicle scattering losses and EM coupling due to incident energies. Again, this is accomplished in terms of frequency and other ensemble problem drivers.

The code also allows the analyst to defeature or modify a CAD or CEM model. This can be used to simplify or augment a model depending upon the type of analysis, sampling frequency, and the desired accuracy. These factors

influence the level of detail needed in the structure model for a given simulation. For example, at lower frequencies, or for situations where high accuracy is unnecessary, or when computational resources are limited, or where certain scatterers do not affect the simulation, the analyst may opt to simplify the model by generating a coarser representation. This leads to a more computationally feasible model.

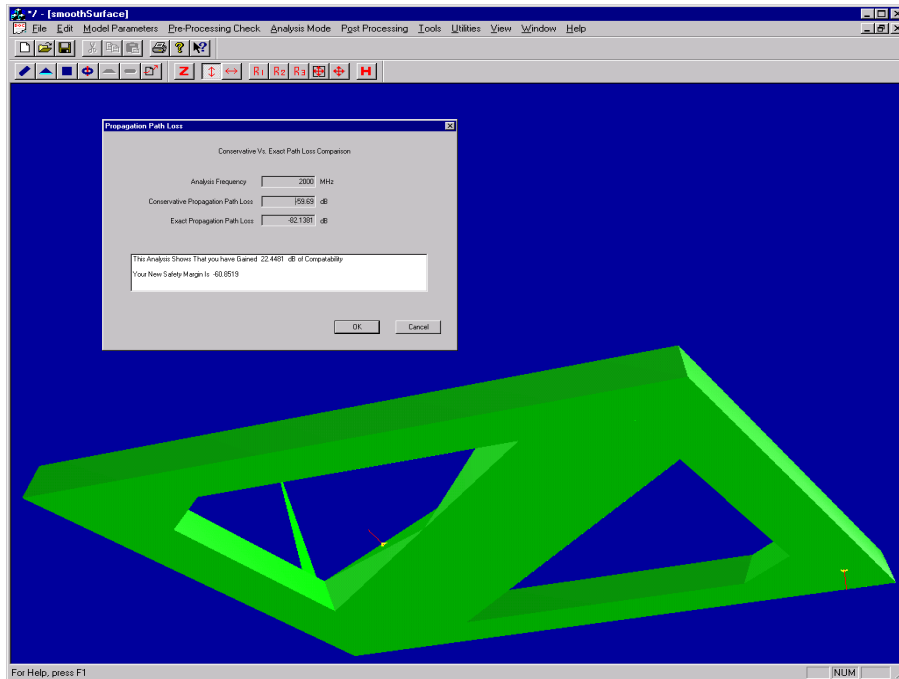
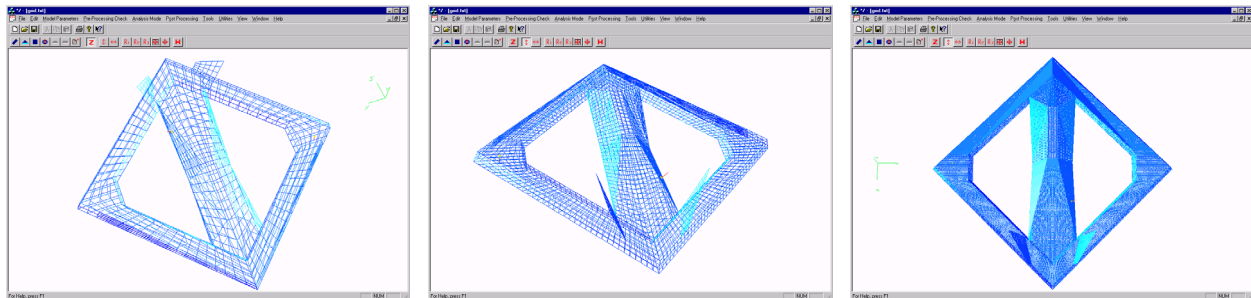

Figure 8. Comparison of Computed Isolation for Coarse and High Fidelity UTD Model at 2 GHz



(a) 25,000 Unknowns at 100 MHz (b) 37,000 Unknowns at 200 MHz (c) 100,000 Unknowns at 633 MHz

Figure 9. Illustration of Multi-Resolution Autogridding Scheme

Computing CEM Observables

Figures 13-15 show examples of the scattered field contour plots that can be produced based on computed surface current densities for several structure models as a function of frequency. The *GEMACS V6.0* code was used as the CEM engine in *E³EXPERT* to calculate these quantities. In Figure 13 for example, the original CAD facet model of the postulated UAV platform was automatically converted into a canonical smooth surface structure and then meshed to predict the hot spots. Source and receiver RF antennas are included in the simulation. The contour plot shown in Figure 13 indicates the location of hot spots (in the near field of radiating antennas and/or where energy adds constructively as the aircraft is illuminated by the ground radar) and cold spots where the energy levels

decay. This information can be used to assist in sensor siting for optimized performance and to develop robust mitigation schemes for reducing antenna jamming potential.

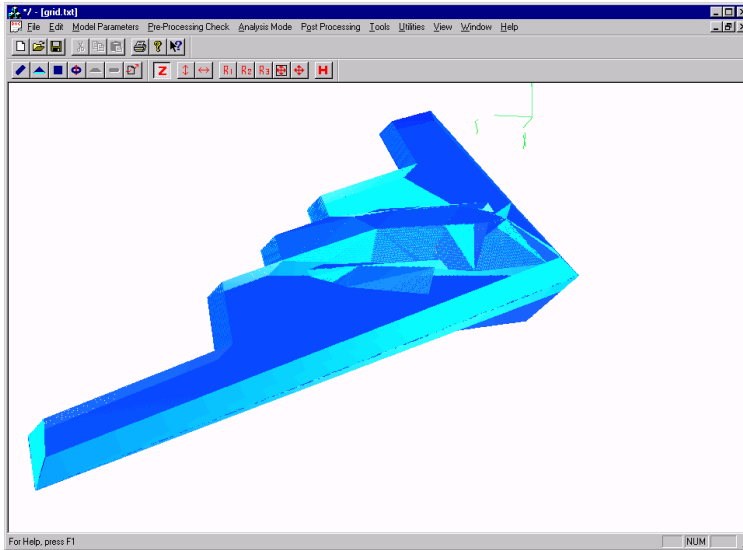
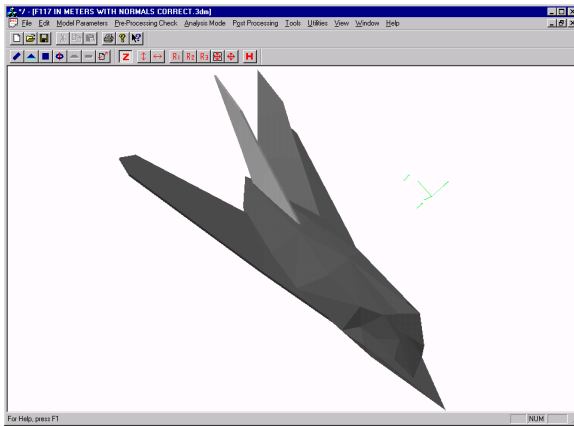
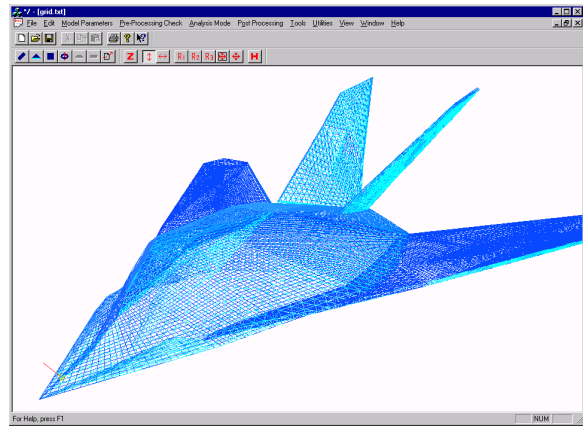

Figure 10. Aircraft Model With 1,185,000 Unknowns at 750 MHz Generated by Autogridded



(a) CAD Model



(b) MoM Mesh Model

Figure 11. Aircraft Model With 820,000 Unknowns at 500 MHz Generated by Autogridded

Antenna patterns for on-structure radiators can also be computed. An example of a 3-D antenna pattern plot using *GEMACS*' pre/post-processing utility called *XGAUGE* is shown in Figure 16 [10]. A similar 3-D plot capability is also being developed for *E³EXPERT*. This will allow an analyst to visualize frequency-dependent gain patterns for antenna-mounted platforms selected from within an EBE scene. In this way, mutual and self antenna coupling can be visually analyzed. Sidelobe reduction can also be directly evaluated as a function of frequency, waveform parametric adjustments, antenna location, near field platform scattering, polarization, and other system influences or perturbations.

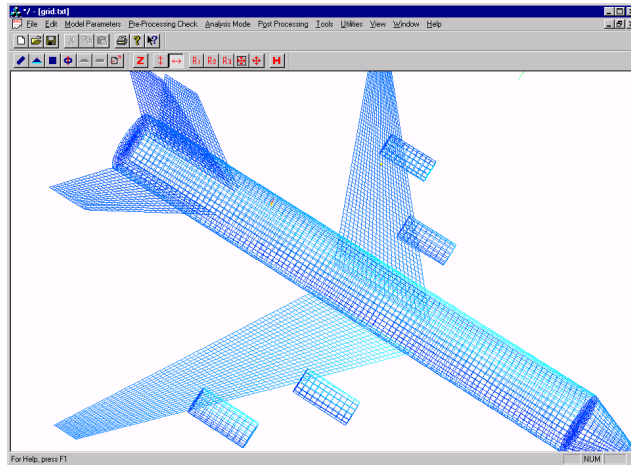

Figure 12. Aircraft Model With 150,000 Unknowns at 200 MHz Generated by Autogridded

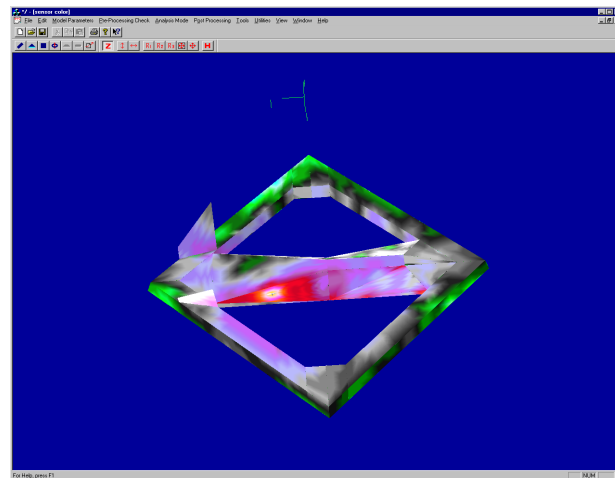

Figure 13. Hot Spots Arising from Surface Currents for UAV Radiators and Incident Fields

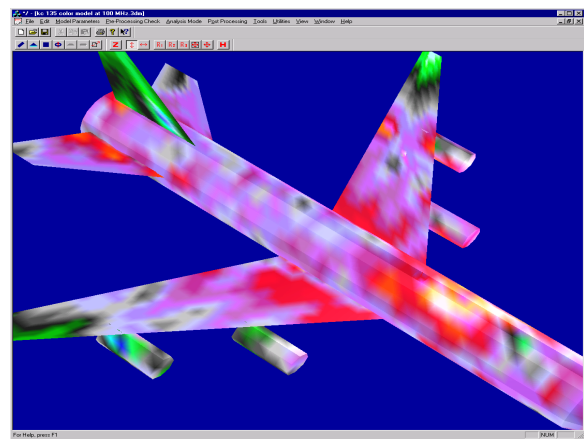
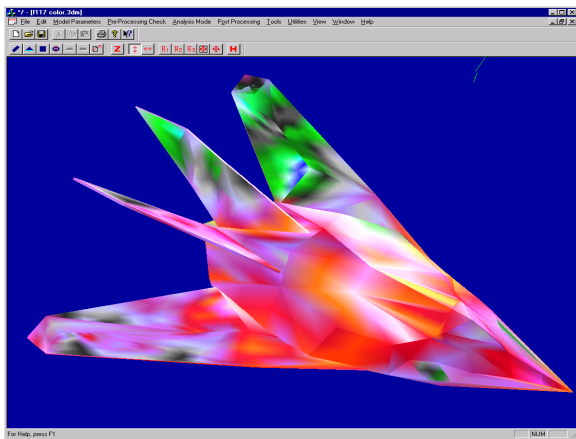

Figure 14. Contour Plots Showing Hot Spots Due to Surface Currents on Airframes

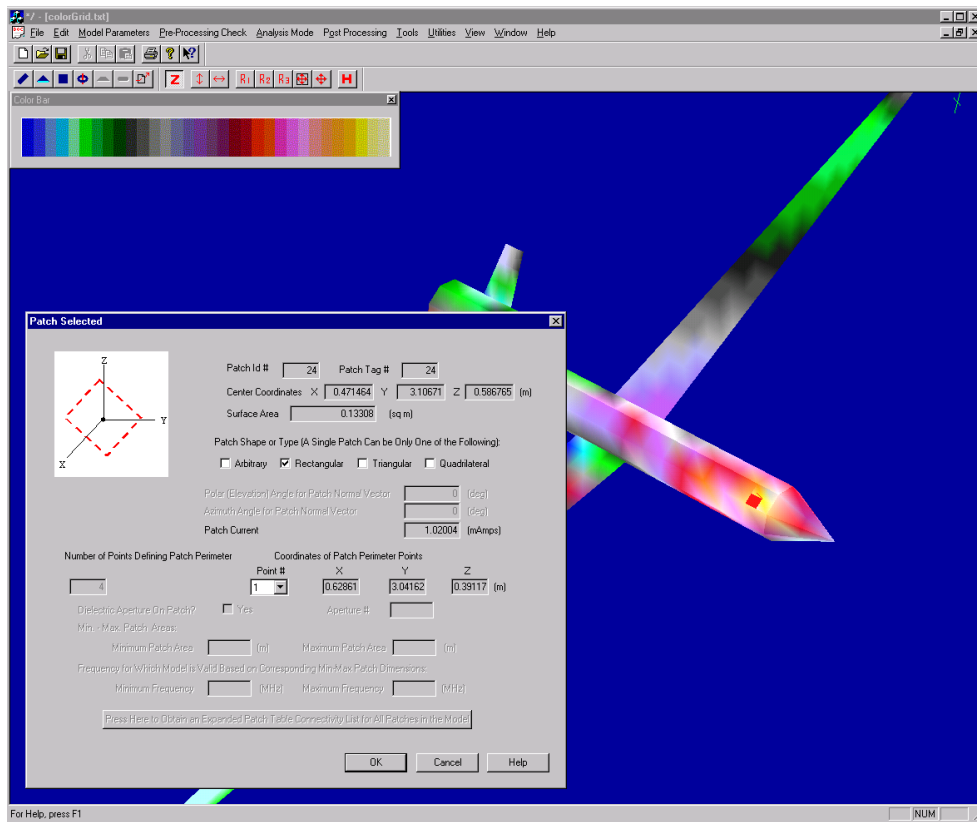

Figure 15. Picking on the Model to Obtain Surface Current Values and Patch Information

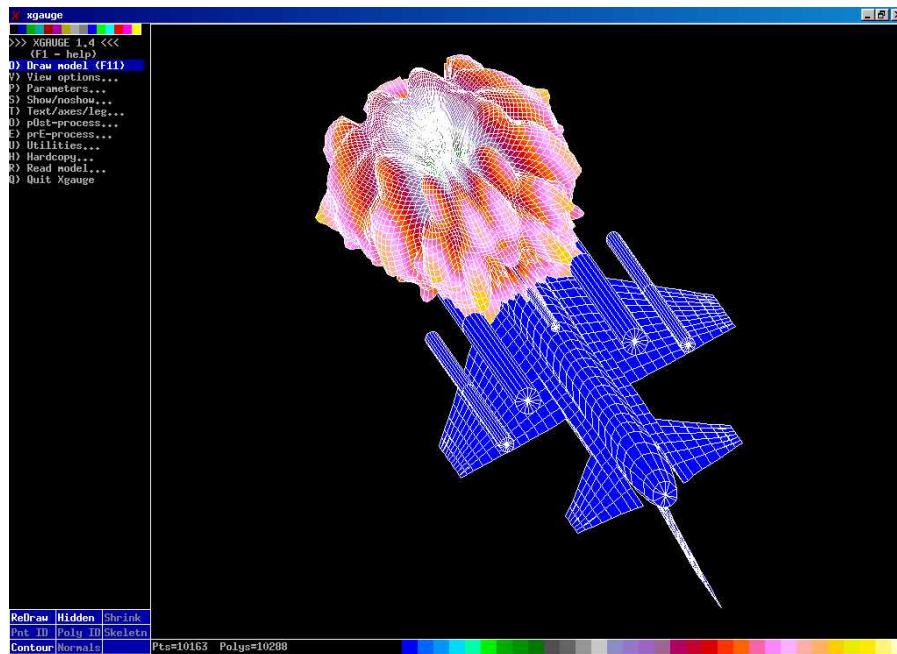

Figure 16. Sculpted Far-Field Pattern on an Aircraft Structure Model [10]

Time-Domain Signal Modeling Simulations

An additional capability is resident within E^3 EXPERT to model individual EM ports (RF antenna front ends, electronic equipments and cable-connector interfaces) to analyze the coupling and leakage effects due to creeping signals arising from induced surface currents. The *SystemView*TM module of E^3 EXPERT provides a time-domain capability to model and analyze such components and coupling paths in a block-step fashion [11]. *SystemView*TM incorporates a wide variety of digital signal processing, communications, and modulation signal libraries. An example of a *SystemView*TM simulation workspace for the case of a direct sequence spread spectrum systems is shown in Figure 17. This figure shows an intended transmitter coupling to a receiver in the presence of an interferer. It is clear from this figure that some waveform distortion exists due to the interference. The path loss and excitation levels calculated in the frequency domain stage are used in the time-domain simulation.

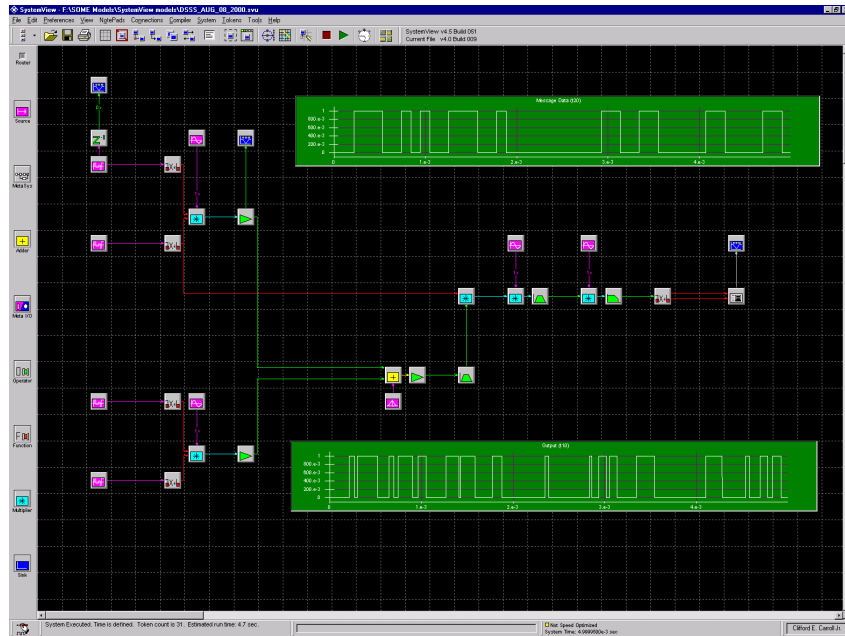

Figure 17. *SystemView*TM Direct Sequence Spread Spectrum Analysis Model

The analysis considers both linear coupling and intermodulation interference. The intermodulation products arise from inherent nonlinearities in the victim receiver due to presence of amplifiers, mixers, and other nonlinear devices. When incident signals from multiple transmitting sources arrive at the receiver and interact with the nonlinear elements in the receiver front-end path, intermodulation frequency products are produced which may fall within the receiver's RF and IF bandwidths. This is illustrated in Figure 18. Nonlinear interference may occur depending on the receiver's RF and IF filtering capacity and the power levels of the intermodulation products. Typically, one is primarily interested in the 3rd-order intermodulation products. However, other orders can be considered in accordance with established techniques based on weakly nonlinear systems theory [13-16].

Expert System Mitigation Solutions

E^3 EXPERT applies a knowledge-based approach to recommend basic interference mitigation solutions. For an EBE scenario, the solutions for mitigating interference or the effects of jamming would be based on, but not limited to the following schemes:

- Employing tactical avoidance measures.
- Automatically switching systems to available high isolation modes.
- Specifying frequency or waveform adjustments to reduce sidelobe coupling potential.
- Applying adaptive filtering and other methods to increase antenna isolation.

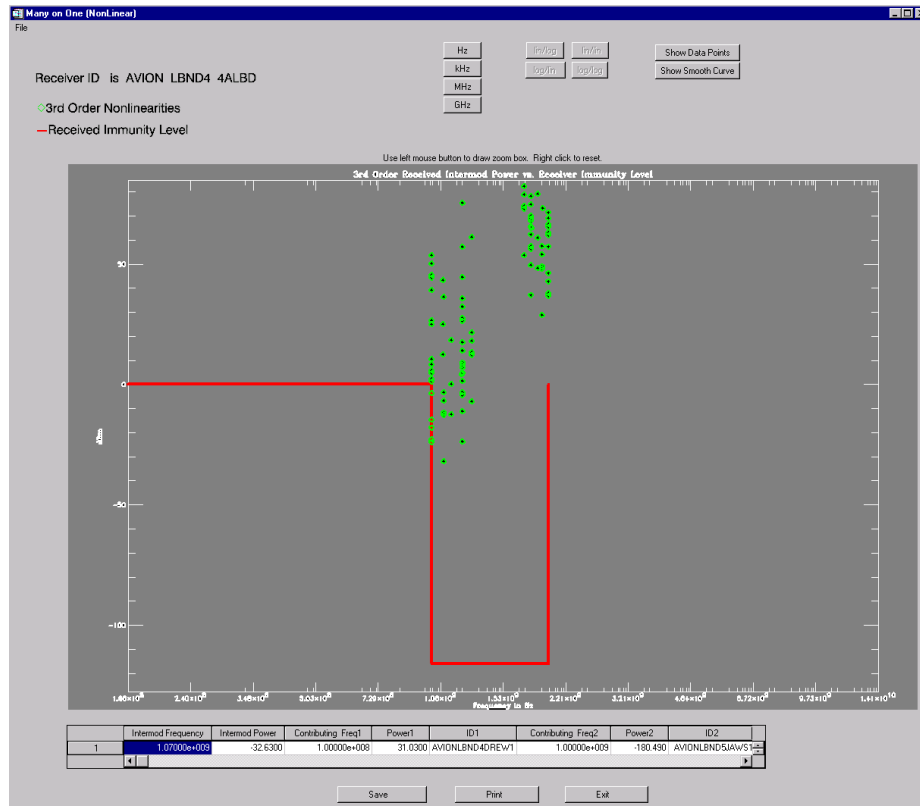

Figure 18. Results of Nonlinear Many-On-One Interference Analysis to a Victim Receiver

SUMMARY

This article discussed a method for modeling RF battlespace scenarios and analyzing complex platform-antenna EM interactions using the E^3 EXPERT technology. This includes analyzing the performance of antennas and systems immersed in EM-rich environments. A system-level (*physical layer*) analysis methodology is applied to the intersystem EBE problem to address antenna design, siting, and performance issues and to determine necessary vulnerability/jamming mitigation solutions.

Digital EBE modeling using E^3 EXPERT addresses the following technical areas: (a) use of hybrid CEM techniques to study individual platform-antenna EM interactions and antenna isolation; (b) solutions for CAD preprocessing and effective approaches for gridding/meshing large, complex systems; and (c) methods for developing multi-fidelity simulation models for different frequencies, accuracy requirements, and problem-solving categories. The EM spectrum models, physics and solution methods within E^3 EXPERT are useful in analyzing and predicting scattering, coupling, interference, and jamming via antenna main and side lobes. The approach also assists in specifying adaptive interference cancellation based on frequency excision schemes as well as basic requirements for frequency management.

Future research will investigate the further definition of performance-validation benchmarks, incorporation of new physics and solution methods (e.g., FDTD and MLFMA), and the utilization of high-performance parallel processing technologies. The latter will assist in optimizing the utility of rigorous CEM modeling, simulation, and analysis techniques to handle electrically large problems accurately and efficiently. Some other areas to be investigated include:

- Adapting existing EM environment databases.
- Incorporating more accurate ground propagation models.
- Enhancing materials modeling techniques.
- Expanding antenna model libraries (arrays, cavity-backed spirals, etc.) for sharing and reuse.
- Extending present methods for graphically post-processing computed results.

References

- [1] A. L. Drozd, A. J. Pesta, et. al. 1998. “*Application and Demonstration of a Knowledge-Based Approach to Interference Rejection for EMC*”, Conference Proceedings of the 1998 IEEE International Symposium on Electromagnetic Compatibility, Denver, CO, 23-28 August 1998, pp. 537-542.
- [2] A. Drozd, J. Miller, et. al., “*Predicting Detailed Electromagnetic Interference Rejection Requirements Using a Knowledge-Based Simulation Approach*”, Newsletter Technical Features Article for the Applied Computational Electromagnetics Society, Vol. 14, No. 1, ISSN 1056-9170, March 1999, pp. 8-11.
- [3] A. Drozd, C. Carroll, et. al., “*Generating Valid CEM Structure Models Directly from CAD Data and Predicting Interference Rejection Requirements Using Knowledge-Based Modeling & Simulation*”, Proceedings (on CD-ROM) of the 1999 Electromagnetic Code Consortium (EMCC) Annual Meeting & Multidisciplinary University Research Initiative (MURI) Reviews, HRL, Malibu, CA, 20-22 April 1999.
- [4] A. L. Drozd, D. D. Weiner, P. K. Varshney, et. al., “*Innovative C⁴I Technologies: ANDRO’s Electromagnetic Environment Effects Expert Processor with Embedded Reasoning Tasker (AE³EXPERT) - A Knowledge-Based Approach to Interference Rejection*”, Final Technical Report AFRL-IF-RS-TR-2000-15 for the Air Force Research Laboratory Information Directorate, Rome Research Site, February 2000.
- [5] A. Drozd, T. Blocher, A. Pesta, L. Cohen, P. Varshney and D. Weiner, “*An Analytical Tool for Predicting EMI Rejection Requirements for Complex Systems Consisting of Communications and Radar Electronics Using an Expert System Approach*”, 7th Annual DoD E³ Program Review, Orlando, FL, 10-14 April, 2000.
- [6] A. Drozd, T. Blocher, A. Pesta, D. Weiner and P. Varshney, “*Advances in the Development of New Tools to Generate Valid CEM Structure Models from CAD Descriptions & Analytically Predicting and Mitigating Undesired Electromagnetic Effects Using a Knowledge-Based Modeling/Simulation Approach*”, Proceedings of the 2000 Electromagnetic Code Consortium (EMCC) Annual Meeting & Multidisciplinary University Research Initiative (MURI) Reviews, St. Louis, MO, 8-10 May 2000.
- [7] A. Drozd, C. Carroll, J. Miller, et. al., “*A New Method For Generating Computational Structure Models to Study the Effects of Undesired High-Power Electromagnetic Energy On Complex Systems*”, Proceedings of the Euro Electromagnetics (EUROEM/AMEREM) Joint Conference: 12th High Power Electromagnetics, 5th Ultra-Wideband Short Pulse Electromagnetics, and 5th Unexploded Ordnance Detection & Range Remediation Conferences, Edinburgh, Scotland, UK, 30 May-2 June 2000.
- [8] A. Drozd, T. Blocher, A. Pesta, et. al., “*Modeling and Simulating Complex Digital Battlespace E³ Scenarios for Air/Ground Target Identification and Analysis of Multiple Platform-Antenna Structure CEM Scattering, Propagation and Coupling Interactions*”, Proceedings of the 2001 Electromagnetic Code Consortium (EMCC) Annual Review Meeting, Kauai, HI, 29 May-1 June 2001.
- [9] A. Drozd, “*Recent Progress on the Application of the E³Expert Capability to Model and Simulate the RF Battlespace to Analyze Complex Platform-Antenna Coupling*” Proceedings of the 2002 Electromagnetic Code Consortium (EMCC) Annual Review Meeting, Albuquerque, NM, 7-10 May 2002.

- [10] "Getting Started with GEMACS and Capabilities of GEMACS" prepared by Advanced Electromagnetics for the US Air Force SEEK EAGLE Office, AFSFEO, Eglin AFB, Contract F08651-99-P-0202.
- [11] *SystemView™* by Elanix, V4.5 User's Guide, Guide to the Communications Library, Guide to the Analog Library, Guide to the Logic Library, Guide to the DSP Library, and Guide to the User Code Option, 2000.
- [12] A. Drozd, T. Blocher, et. al., "Illustrating the Application of Expert Systems to Computational Electromagnetics Modeling and Simulation", Conference Proceedings of the 14th Annual Review of Progress in Applied Computational Electromagnetics, Monterey, CA, 16-20 March 1998, pp. 36-41.
- [13] I. Demirkiran, D. Weiner, P. Varshney, and A. Drozd, "Effect of Nonlinearities on Spread Spectrum Communications", Proceedings of the 32nd Asilomar Conference on Circuits, Systems and Computers, Monterey, CA, November 1998.
- [14] D. Weiner, A. Drozd, K. Sunderland & I. Popitich "Analysis and Modeling of Weakly Nonlinear Systems", Newsletter Technical Features Article for the Applied Computational Electromagnetics Society, Vol. 15, No. 1, ISSN 1056-9170, March 2000.
- [15] D. Weiner and A. Drozd, "Power Considerations for the Measurement of Nonlinear Effects", Newsletter Technical Features Article for the Applied Computational Electromagnetics Society, Vol. 15, No. 2, ISSN 1056-9170, pp. 13-18, July 2000.
- [16] D. Weiner and A. Drozd, "Power Series Analysis of Weakly Nonlinear Circuits", Newsletter Technical Features Article for the Applied Computational Electromagnetics Society, Vol. 16, No. 2, ISSN 1056-9170, pp. 51-56, July 2001.