

Ultra-Wideband Bandpass Filter Based on Parallel-Coupled Microstrip Lines and Defected Ground Structure

Li Yang, Yang Hongchun, Wang Yawei, and Xiao Shaoqiu

School of Physical Electronics

University of Electronic Science and Technology of China, Chengdu, 610054, China
 liyang8311@gmail.com, yhc690227@sina.com, and wangyawei667@126.com

Abstract — A compact planar microstrip bandpass filter with 3.1 GHz – 10.6 GHz bandwidth, below 1 dB in-band insertion loss, 0.2 ns – 0.6 ns group delay and out-of-band rejection level better than -10 dB is presented for ultra-wideband (UWB) applications. The desired UWB is realized by etching a defected ground structure (DGS) in the ground plane and loading a folded stepped-impedance stub by one of the coupling microstrip lines. This can offer two transmission zeros at lower and upper edges of the passband, which improve the passband selectivity and out-of-band rejection significantly. An equivalent lumped circuit model is introduced; the result of the circuit model fits the EM model well. The simulated and measured results are in good agreement

Index Terms - Bandpass filter, coupled microstrip lines, defected ground structure (DGS), and folded stepped-impedance stub.

I. INTRODUCTION

The ultra-wideband bandpass filter with compact size, low insertion loss, and good out-of-band rejection is always an interesting research field since the standard of ultra-wideband (UWB) communications was published by the Federal Communications Committee (FCC) in 2002 [1]. The multiple-mode resonator (MMR) [2, 3] and the defected ground structure [4-7] were adopted to implement the ultra-wideband bandpass filter. The bandwidth of the proposed filters covers the whole UWB but the insertion loss and the rejection band need further improvement. A wideband bandpass filter with simple structure and good performance based on the hybrid microstrip

and coplanar waveguide (CPW) was suggested in [8], but the out-of-band rejection level at the upper frequency edge was poor.

II. UWB BANDPASS FILTER DESIGN

The structure and dimensions of the proposed UWB bandpass filter is shown in Fig. 1 (a) and (b). A folded stepped-impedance stub is loaded by one of the coupled microstrip lines and a DGS structure with two slots etched in the ground plane below the coupled transmission lines. The dimensions of Fig. 1 (b) are enlarged in order to show the structure clearly. A Rogers duroid 5880 substrate is used with thickness of 0.508 mm and relative permittivity 2.2. The folded stepped-impedance stub offers a transmission zero at the lower frequency edge and the DGS structure with two slots generates the other transmission zero at the upper frequency edge of the bandpass filter.

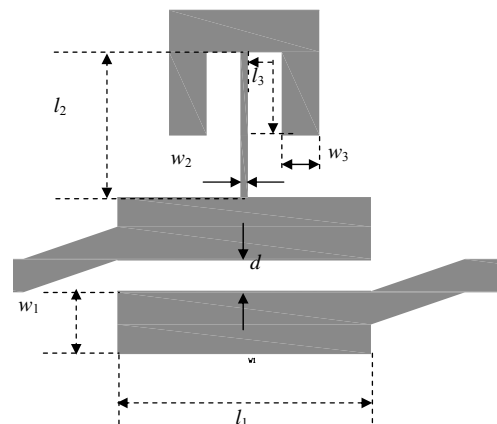

(a) Top view.

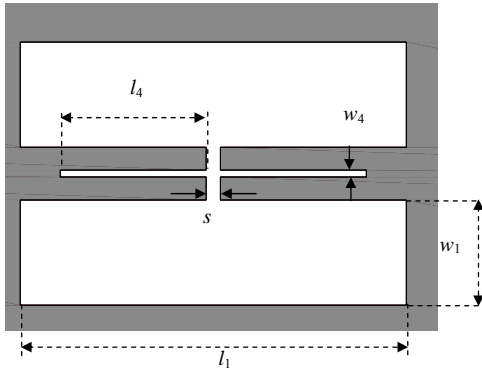

(b) Bottom view.

Fig. 1. Structure and dimensions of the proposed UWB bandpass filter for (a) coupled microstrip lines with folded stepped-impedance stub and (b) DGS with two slots.

The center frequency and the bandwidth of the proposed filter are mainly decided through the length of l_1 and the width of w_1 . Figure 2 presents the simulation results of the S-parameters generated using HFSSTM. Figure 2 (a) shows that the bandwidth is widened significantly when the length of l_1 is increased while the width of w_1 is fixed. Similarly, Fig. 2 (b) suggests that the bandwidth is also widened slightly when the width of w_1 decreased while the length of l_1 is fixed. The bandwidth covers 3.1 GHz – 10.6 GHz while the length of l_1 is about a half wavelength (13.5 mm) corresponding to the center frequency and the width of w_1 , which is about 3 mm.

The frequency of the transmission zero at the lower edge is mainly decided by the length of l_2 and l_3 while the ratio of w_2 and w_3 is fixed as 1 : 4 (similar to the analysis of [9]). Figure 3 offers the curves of the S_{21} parameter simulated by HFSSTM. The out-of-band rejection level at 3.1 GHz is below -10 dB when $l_2 = 7$ mm and $l_3 = 6$ mm. The frequency of the transmission zero at the upper edge is mainly decided by the length of l_4 when the values of w_4 is smaller than 0.5 mm. Figure 4 presents the curve of S_{21} parameter simulated using HFSSTM. The out-of-band rejection level at 10.6 GHz is below -10 dB when $l_4 = 5.1$ mm and $w_4 = 0.3$ mm.

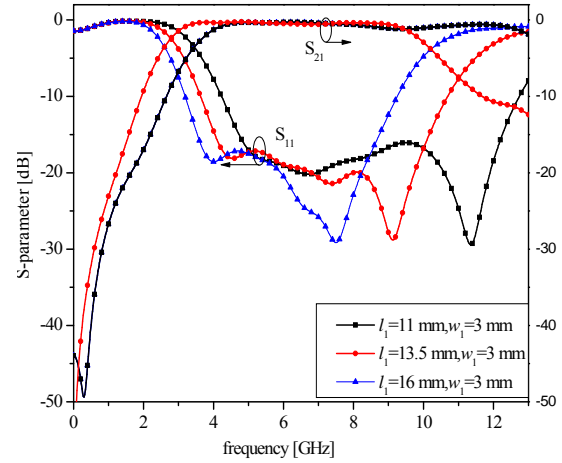

(a)

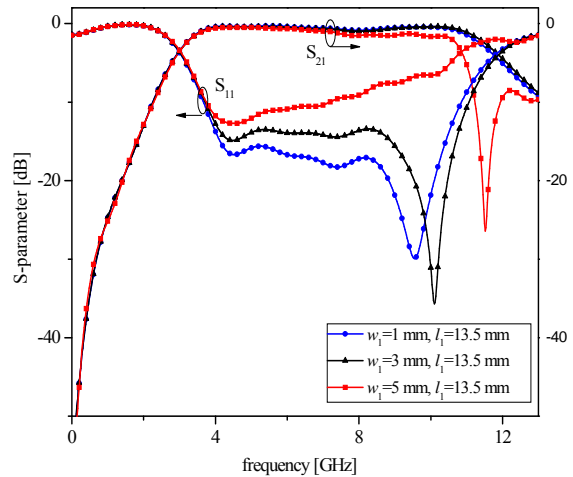

(b)

Fig. 2. (a) The simulated S-parameter curves for different l_1 values and (b) the simulated S-parameter curves for different w_1 values.

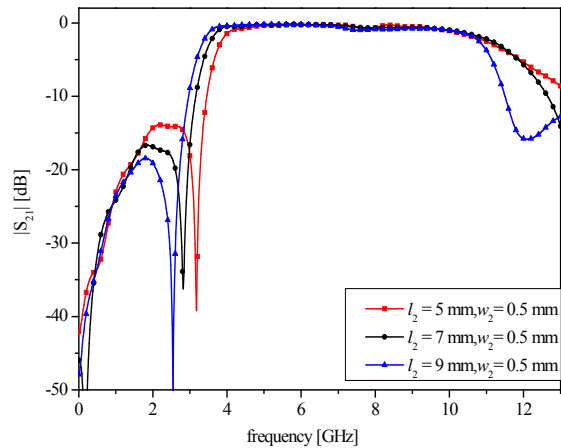

(a)

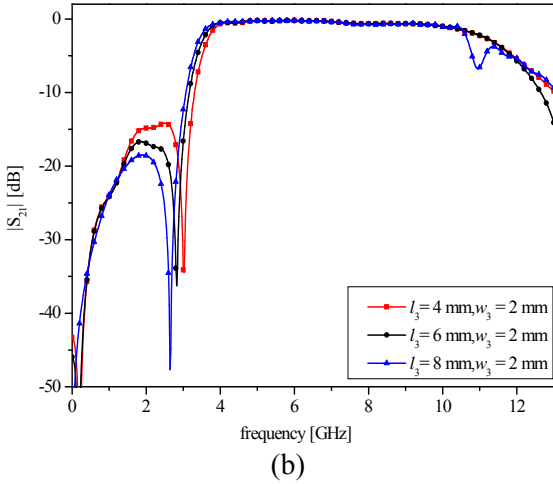

Fig. 3. (a) The simulated S_{21} for different l_2 values and (b) the simulated S_{21} for different l_3 values.

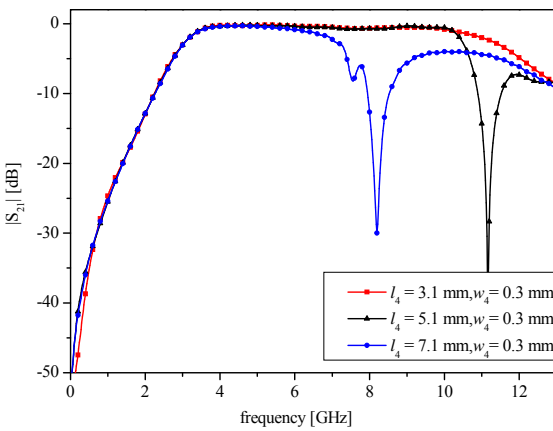
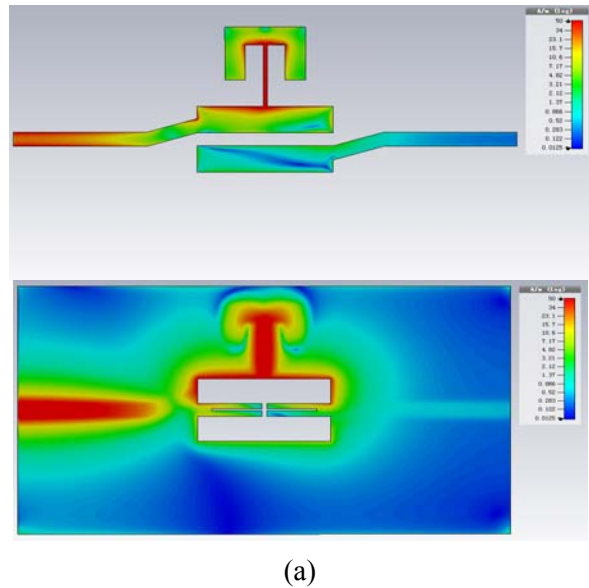

Fig. 4. The Simulated S_{21} for different l_4 values.

In Fig. 5, the surface current distribution of the proposed filter is depicted. In this figure, the current distributions at three different frequencies are presented. The first lower transmission zero is at 2.7 GHz, the upper transmission zero is at 11.3 GHz and the mid-frequency in the passband is at 7 GHz. In Fig. 5 (a), the current is mainly located at the folded stepped-impedance stub. In Fig. 5 (b), the current is mainly located at the DGS. In Fig. 5 (c), the current is uniformly distributed along the filter. This implies that the lower transmission zero is mainly due to the folded stepped-impedance stub, while the DGS introduces the upper transmission zero.

In order to further explain the roles of the proposed folded stepped-impedance stub and the

defected ground structure, an equivalent lumped circuit model is introduced. Figure 6 shows the schematic diagram of the equivalent circuit. The 1st part of the circuit represents the folded stepped impedance stub, which introduces the first transmission zero at low frequency. The 2nd part represents the bandpass characteristics of the coupled microstrip lines. Finally, the 3rd part represents the role of the defected ground structure, which introduces the second transmission zero at high frequency. The capacitors and inductors in the 3rd part represent the resonant characteristic of the DGS. The resistors R1 and R2 represent the radiation losses when the operating frequency is high.



(a)

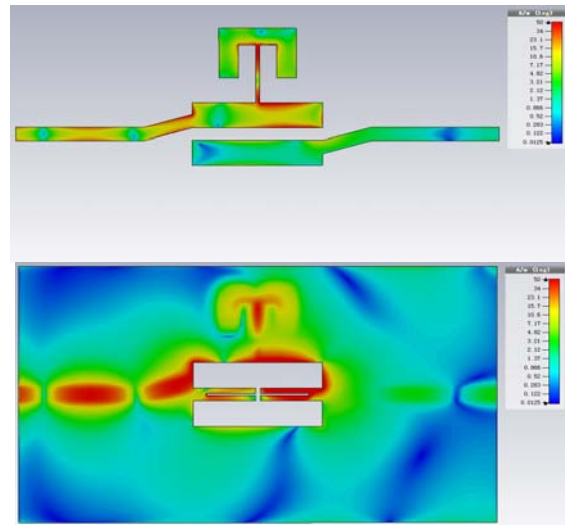

(b)

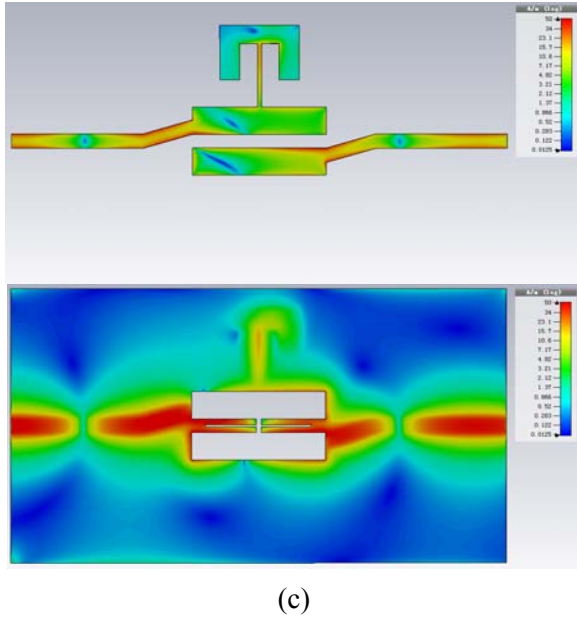

Fig. 5. The current distribution of the top plane and the ground plane at (a) 2.7 GHz, (b) 11.3 GHz, and (c) 7 GHz.

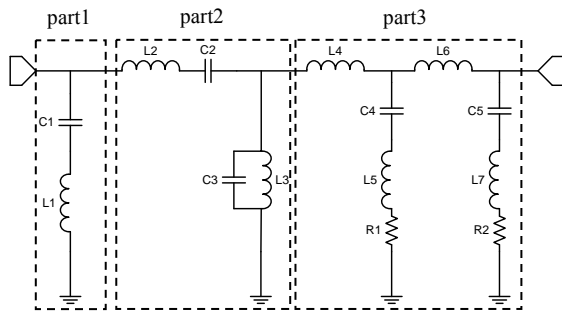

Fig. 6. The equivalent lumped circuit model.

The parameters of the equivalent lumped circuit are as follows: $C1 = 1.45$ pF, $L1 = 2.4$ nH, $L2 = 0.82$ nH, $C2 = 0.68$ pF, $L3 = 1.878$ nH, $C3 = 0.538$ pF, $L4 = 0.251$ nH, $C4 = 0.123$ pF, $L5 = 1.63$ nH, $R1 = 0.66$ Ohm, $L6 = 0.64$ nH, $C5 = 0.197$ pF, $L7 = 0.714$ nH, $R2 = 2.36$ Ohm.

Figure 7 shows the S parameters simulated using the equivalent circuit model and the EM model simulator. One can notice that both results are in good agreement.

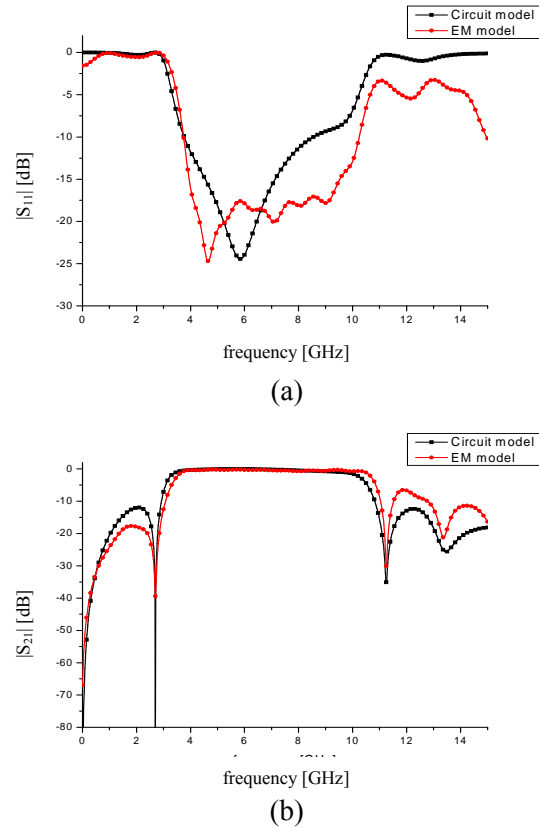

Fig. 7. The simulated (a) S_{11} and (b) S_{21} parameters of the circuit model versus EM model.

III. RESULT AND DISCUSSION

The photograph of the top and bottom view of the proposed UWB bandpass filter is shown in Fig. 8. The total size is about $50 \text{ mm} \times 30 \text{ mm}$ including two SMA connectors. The optimized parameters of the filter are $w_1 = 3.1$, $w_2 = 0.5$, $w_3 = 2$, $w_4 = 0.3$, $l_1 = 13.5$, $l_2 = 7$, $l_3 = 6$, $l_4 = 5.1$, $d = 1.5$, and $s = 0.5$ (all in millimeters). The simulated and measured results of the S_{11} , S_{21} , and the group delay are shown in Fig. 9. The experimental results were measured by an Agilent E8363B vector network analyzer. Figure 9 suggests that the working bandwidth of the proposed filter covers the whole UWB bandwidth from 3.1 GHz to 10.6 GHz, with an insertion loss less than 1.5 dB through the whole passband and the in-band group delay is about 0.2 ns – 0.6 ns. The simulated and measured results are in good agreement. The deviation might be introduced by the loss tangent of the substrate material and the parasitic effects of the SMA connectors.

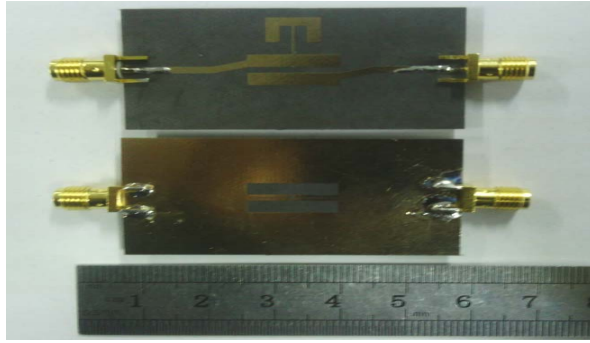

Fig. 8. Photograph of the proposed UWB bandpass filter.

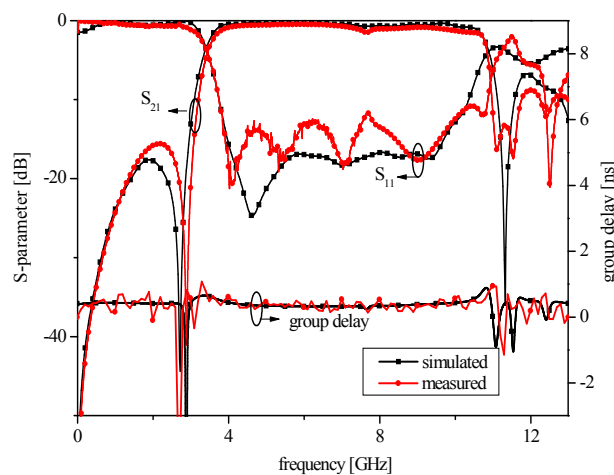

Fig. 9. The simulated and measured S-parameters and the group delay of the proposed filter.

IV. CONCLUSION

In this paper, a structure of a folded stepped-impedance stub with a defected ground structure of two slots is proposed. The proposed configuration introduces two transmission zeros at both, lower and upper edges of the passband. This is in order to improve the out band rejection, and thus the coupled microstrip lines combined with the DGS can cover the whole UWB passband. In order to explain the role of the folded stepped impedance stub and the DGS, an equivalent lumped circuit model is introduced and analyzed. The results of the simulated circuit model, the EM model simulator, and the measurements are in good agreement.

ACKNOWLEDGMENT

This project was supported by the Fundamental Research Funds for the Central Universities.

REFERENCES

- [1] FCC, "Revision of part 15 of the commission's rules regarding ultra-wideband transmission systems," *Tech. Rep.*, ET-Docket 98-153, FCC02-48, April 2002.
- [2] L. Zhu, S. Sun, and W. Menzel, "Ultra-wideband (UWB) bandpass filter using multiple-mode resonator," *IEEE Microw. Wirel. Compon. Lett.*, vol. 15, no. 11, pp. 796-798, 2005.
- [3] K. Wu and X. Zhang, "Development of packaged ultra-wideband bandpass filters," *IEEE Trans. Microw. Theory Tech.*, vol. 58, pp. 220-228, Jan. 2010.
- [4] F. Karshenas, A. R. Mallahzadeh, and J. Rashed-mohassel, "Size reduction and harmonic suppression of parallel coupled line bandpass filters using defected ground structure," *Appl. Comp. Electro. Soc. (ACES) Journal*, vol. 25, no. 2, pp. 149-155, Feb. 2010.
- [5] M. Al Sharkawy, A. Boutejdar, F. Alhefnawi, and O. Luxor, "Improvement of compactness of lowpass/bandpass filter using a new electromagnetic coupled crescent defected ground structure resonators," *Appl. Comp. Electro. Soc. (ACES) Journal*, vol. 25, no. 7, pp. 570-577, July 2010.
- [6] U. Sajjad and A. Sheta, "Compact bandpass filters with bandwidth control using defected ground structure (DGS)," *Appl. Comp. Electro. Soc. (ACES) Journal*, vol. 26, no. 7, pp. 624-630, July 2011.
- [7] W. Shao, J.-L. Li, "Accurate modeling of a patterned ground and its application to microwave filters," *Appl. Comp. Electro. Soc. (ACES) Journal*, vol. 27, no. 7, pp. 596-602, July 2012.
- [8] L. Zhu, S. Sun, and W. Menzel, "Ultra-wideband (UWB) band-pass filter with hybrid microstrip / CPW structure," *IEEE Microw. Wirel. Compon. Lett.*, vol. 15, no. 12, pp. 844-846, 2005.
- [9] L. Zhu and W. Menzel, "Compact microstrip bandpass filter with two transmission zeros using a stub-tapped half-wavelength line resonator," *IEEE Microw. Wirel. Compon. Lett.*, vol. 10, no. 1, pp. 16-18, 2003.



Li Yang received the bachelor's degree and the master's degree from the Information Engineering University and the University of Electronic Science and Technology of China, in 2006 and 2009, respectively. He is currently working toward the Ph.D. degree

in the University of Electronic Science and Technology of China.



Yang Hongchun was born in Sichuan Province, China, in 1969. He received the Ph.D. degree in radio physics from the University of Electronic Science and Technology of China (UESTC), Chengdu, China, in 2008. He is Professor of School of Physical Electronics of

UESTC. His current research interests are in the areas of antenna theory and techniques, theoretical physics, electromagnetic science and technology and microwave passive components.



Wang Yawei was born in Shanxi Province, China, in 1984. He is working toward a master's degree. His research interests include transmission line theory, and microwave passive and active components

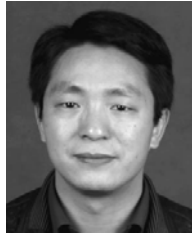

Xiao Shaoqiu received the Ph.D. degree in electromagnetic field and microwave engineering from the University of Electronic Science and Technology of China (UESTC), Chengdu, China, in 2003. From January 2004 to June 2004, he was with the Institute of

Applied Physics, UESTC as an Assistant Professor. From July 2004 to March 2006, he was with the wireless Communications Laboratory of NICT Singapore, National Institute of Information and Communications Technology. In April 2006, he became an Associate Professor with UESTC and a Professor in 2010. His research interests include planar antenna and arrays reconfigurable antenna, antenna integration and packaging, millimeter wave circuits and systems and ultrawideband communications.